



**northern health**  
*the northern way of caring*



# Before, During and After Hip and Knee Replacement Surgery

**A Patient's Guide**



**northern health**  
*the northern way of caring*



## Acknowledgments

This revised booklet is based on information produced over the years by a variety of organizations. We would like to acknowledge the contributions made by:



The Arthritis Society, BC & Yukon Division



The Mary Pack Arthritis Program



Hip Hip Hooray



BC Orthopedic Association



Canadian Orthopedic Foundation

This edition of the booklet was developed by Northern Health staff at University Hospital of Northern British Columbia. The original edition was developed by OASIS (OsteoArthritis Service Integration System) in partnership with staff at:



Vancouver Island Health Authority



Northern Health



Interior Health Authority



Fraser Health Authority



Providence Health Care

Your feedback and suggestions on this booklet are welcome.

You are a candidate for hip or knee replacement surgery. Patients who are prepared for surgery and who take part in their care can recover in less time and with less pain. This booklet will give you the general information you need to get yourself, your family and your home ready for surgery. Read this booklet with care. We hope that you find this booklet a useful reference guide before, during and after your joint replacement surgery.

This booklet is a guide to accompany your surgeons directions. Please call your surgeon's office with any questions or signs of infection. To have the best possible outcome in your hip or knee replacement remember the importance of: (bullet each) stopping smoking; careful diabetic control; following the HbA1C; weight management; and proper nutrition.

**IMPORTANT: If your surgeon or health care team gives you different advice than what has been provided in this booklet, please follow the specific directions you receive.**

# **My Joint Replacement Plan**

# Contents

## **Hip Surgery**

- Hip Anatomy ..... 7
- Hip Replacement Surgery ..... 8
- Joint Attachment ..... 9
- Hip Precautions ..... 10

## **Knee Surgery**

- Knee Anatomy ..... 13
- Knee Replacement Surgery ..... 13
- Joint Components and Attachment..... 14
- Knee Precautions ..... 16

## **Before Surgery**

- Home Set-Up ..... 19
- Exercise Before Surgery ..... 24
- Nutrition Before Surgery ..... 26
- Weight Management Before Surgery ..... 27
- Mental Health and Wellness Before Surgery ..... 32
- Stop Smoking Before Surger ..... 35
- Pre-Operative Education ..... 38
- Pre-Admission Clinic ..... 38
- Final Checklist Before Surgery ..... 40

## **During Your Hospital Stay**

- Day of Surgery..... 42
- Length of Hospital Stay ..... 43
- Rehabilitation ..... 44
- Pain Control..... 45
- Anti-Coagilation ..... 47
- Going Home ..... 47

## **After Surgery**

- Recovery At Home..... 49
- Everyday Activity Guidelines ..... 52
- Returning to Work..... 57
- Complications ..... 58
- Dental Work and Medical Procedures..... 61

## **Resources** ..... 63

## **When To Seek Medical Attention** ..... 65

# Hip Surgery

In this section, you will learn about:

- Hip Anatomy
- Hip Replacement Surgery
- Joint Components and Attachment
- HIP PRECAUTIONS

## Hip Anatomy

The hip joint is a ball and socket joint – that’s why you can move your hip in many directions. The ball is the round head of the thigh bone (femur). It moves in the socket of your pelvis (acetabulum). Muscles and ligaments support and strengthen the joint.

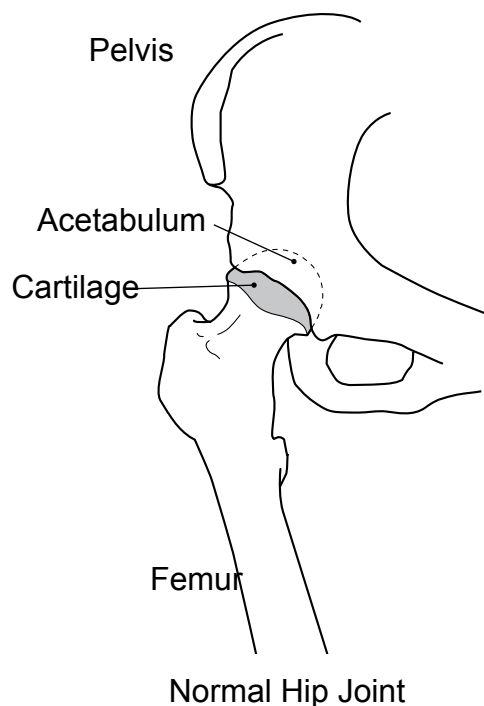

## Hip Disease

The most common reason for joint replacement surgery is **OSTEOARTHRITIS**. Osteoarthritis results in the breakdown of cartilage on the ends of the bones. It usually appears in joints that carry your body weight, such as hips and knees. Osteoarthritis can cause joint pain and stiffness. Advanced joint damage can be repaired through joint replacement surgery.

Other disease conditions may also lead to damage of the joint, requiring joint replacement surgery. These include conditions such as rheumatoid arthritis, bone infection or a lack of blood supply to the bone. Talk to your doctor if you have questions about your joint health.

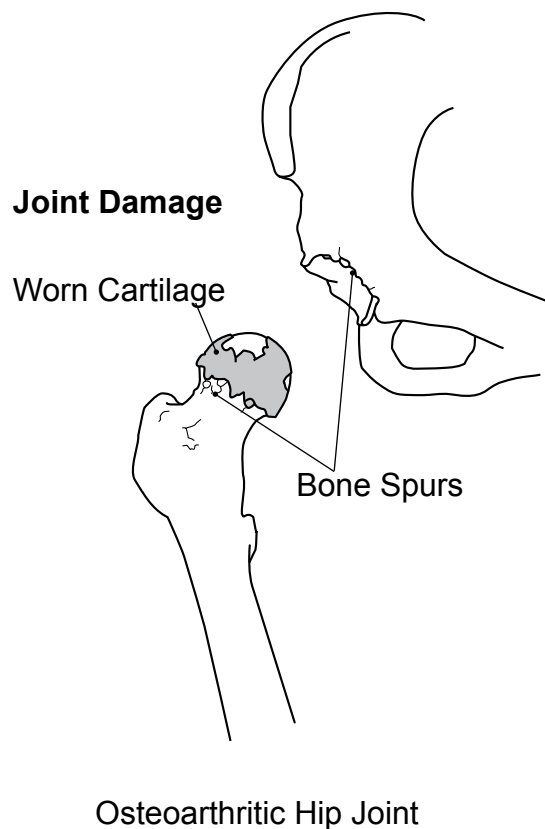

## Hip Replacement Surgery

In total hip replacement surgery, the surgeon replaces the diseased joint with an artificial joint (prosthesis). First, the surgeon makes an incision and moves the muscles and ligaments away from the hip joint. Then the head of the thigh bone is replaced with an artificial ball and stem. The pelvic socket is smoothed and lined with a molded shell. Then the joint is put back together with the ball fitted into the shell. Once the new joint is in place, the muscles and ligaments are repaired. Your skin is closed with stitches or staples (staples are metal clips that hold your skin together while the incision heals). This surgery takes about one and a half hours.

Today, many patients who have hip replacement surgery can move their joint more easily, have less pain and are able to walk more comfortably for up to 25 years after surgery.

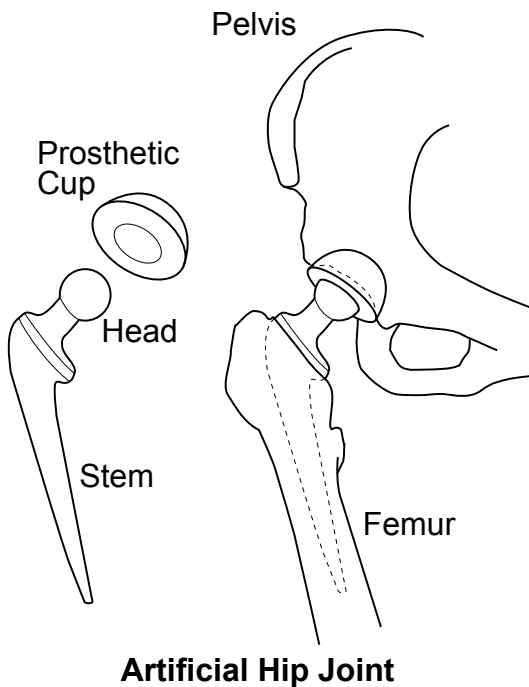

**Artificial Hip Joint**

## Hip Resurfacing

Hip resurfacing is a type of hip replacement surgery that may be suggested by your surgeon based on a number of factors including the degree of damage to your joint and your overall health.

In this surgery, the surgeon replaces the diseased joint with a special form of artificial joint (resurfacing prosthesis). First, the surgeon makes an incision and moves the muscles and ligaments away from the hip joint. Then the damaged cartilage and some parts of the bone surface are removed from the head of the thigh bone (femur) and the hip socket (acetabulum). A ball-shaped cap is placed over the head of the thigh bone. The hip socket is smoothed and lined with a molded shell. Once the joint is put back together, the muscles and ligaments are repaired. Your skin is closed with stitches or staples (staples are metal clips that hold your skin together while the incision heals).

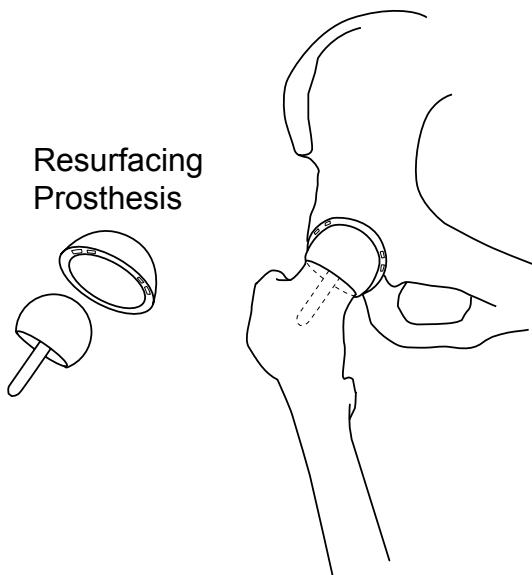

**Resurfaced Hip Joint**



## **Hip Revision (Repeat)**

Some people who have had a hip replacement may need another surgery because:

- The joint has dislocated.
- The joint is loose or worn out.
- There has been bone loss or an infection in the joint.

These surgeries can be more complex and you may need more rehabilitation after surgery. You may not be able to carry as much weight on your new joint while you recover.

## **Joint Components (Prostheses)**

Artificial joint components may be made of medical-grade metal, plastic, ceramic or some combination of these materials. Your surgeon will determine the type of joint to be used, matching your individual needs with a suitable type of material.

## **Joint Attachment (Fixation)**

The type of fixation used to secure the artificial joint in your body will depend on a variety of factors including your age, disease type and bone quality.

**CEMENTED:** The artificial joint pieces are secured to the bone with a quick-hardening adhesive.

**CEMENTLESS:** The artificial joint pieces are closely fitted into the bones. These pieces are covered in a rough material that encourages bone growth. Bone growth into the artificial joint can provide additional long-term joint stability. Some parts of the artificial joint may be screwed in place to keep the joint stable.

**HYBRID:** In this type of surgery, one piece of the artificial joint is attached with cement while the other piece is covered in a rough material that encourages bone growth. Bone growth into the artificial joint can provide additional long-term joint stability. Some parts of the artificial joint may be screwed in place to keep the joint stable.

## HIP PRECAUTIONS

After Hip Surgery, you will need to follow **HIP PRECAUTIONS** for **6 WEEKS** unless otherwise advised by your surgeon. These activity restrictions will help your joint to heal and reduce the risk of hip dislocation. See “Complications” section for more information, page 58.

*Shaded leg is the surgical leg.*

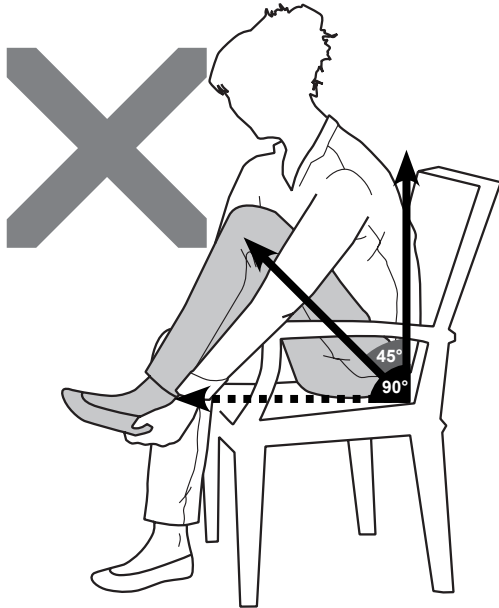

**DO NOT** bend your hip past 90 degrees

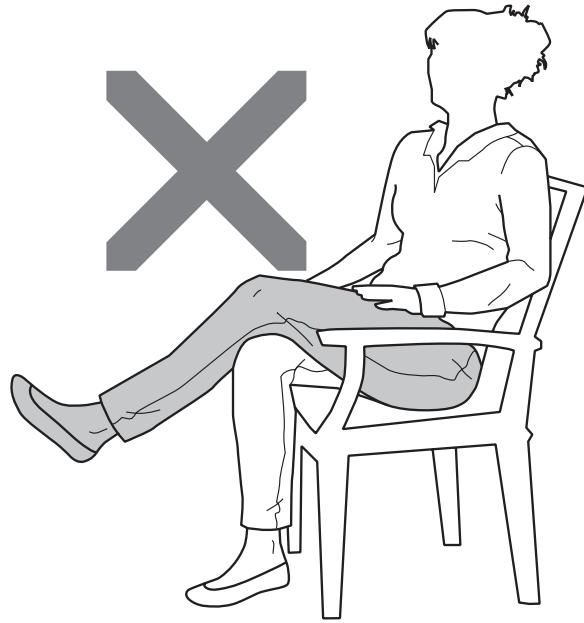

**DO NOT** cross your legs at the ankles or knees

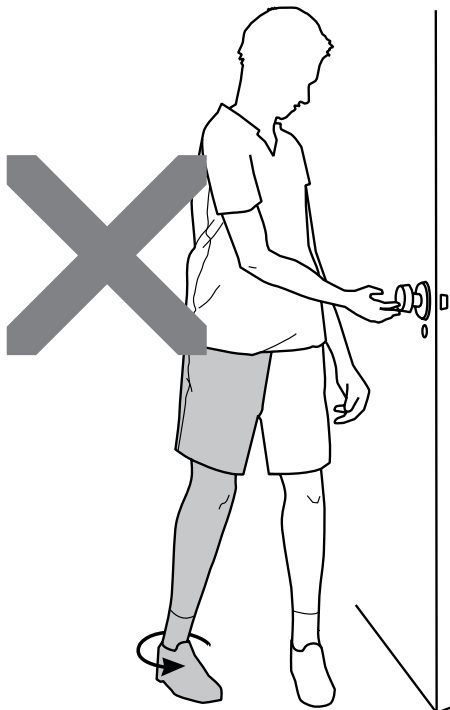

**DO NOT** twist your body or legs

Additional Notes for Hip Surgery and Precautions:

---

---

---

---

---

---

---

---

---

---

**Things you CAN DO after hip surgery:**

DO sit on a raised chair or use a high-density foam cushion to increase surface heights. Use a raised toilet seat. (see page 53 for how to sit)

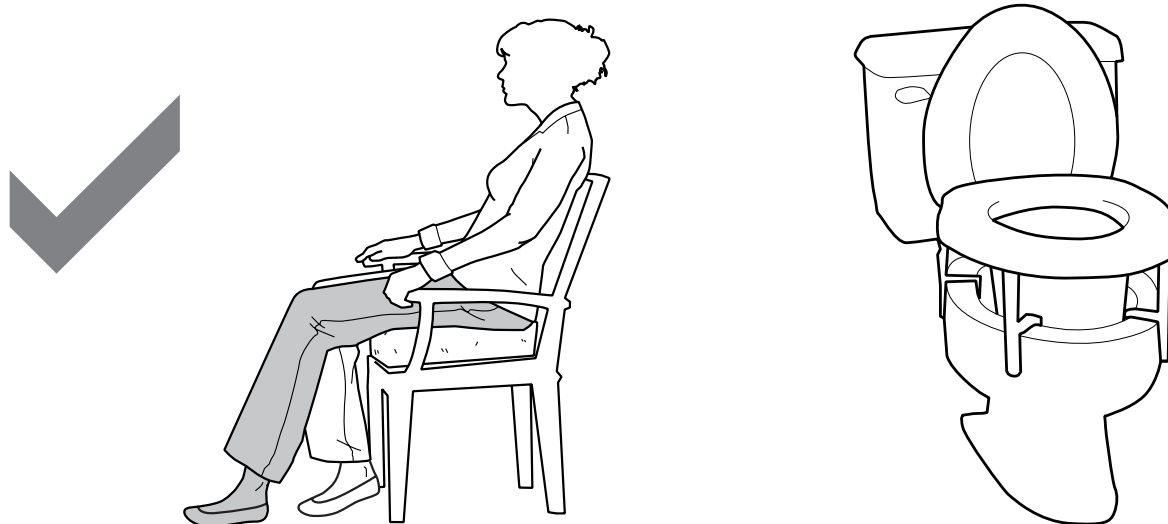

**DO use long-handled aids, such as a shoehorn and reacher, to help you dress and pick up items.**

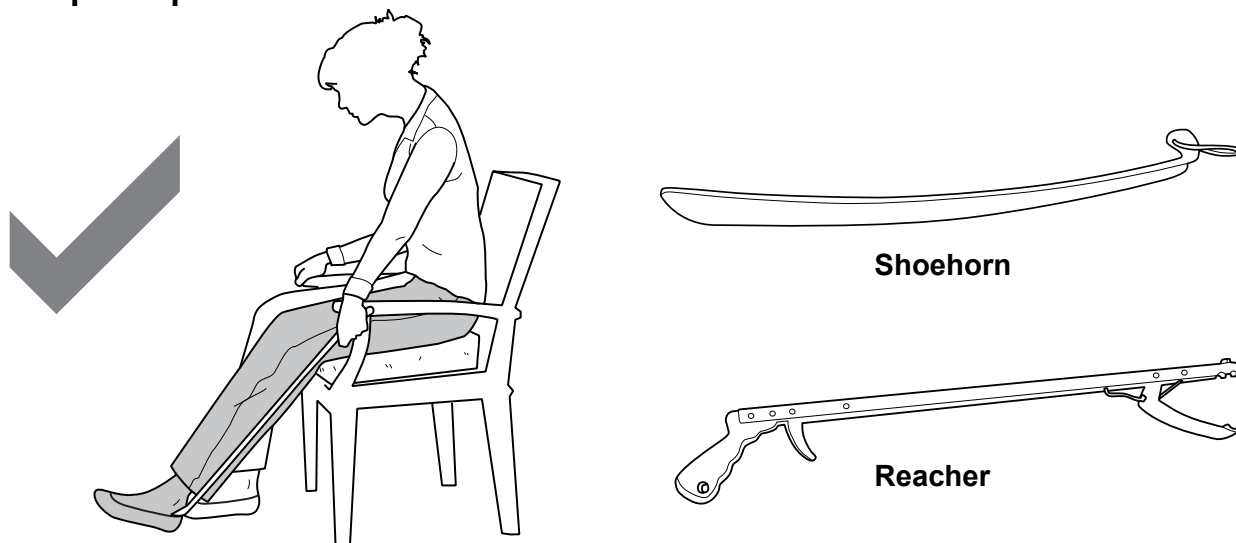

**DO sleep with pillows between your legs for the first 3 months after surgery.** You may require assistance placing the pillows or choose to use an extra-long pillow.

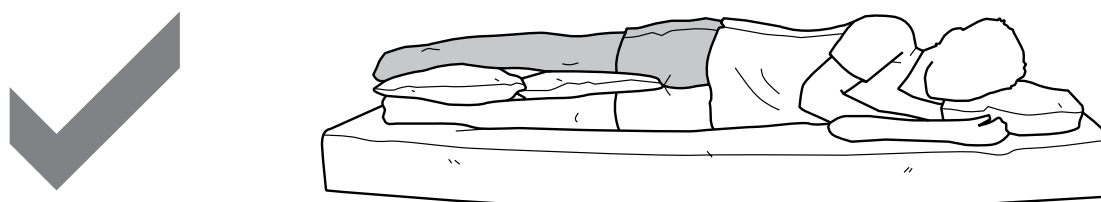

# Knee Surgery

In this section, you will learn about:

- Knee Anatomy
- Knee Replacement Surgery
- Joint Components and Attachment
- KNEE PRECAUTIONS

## Knee Anatomy

The knee joint is where the thigh bone (femur) meets the shin bone (tibia). The knee is a hinge joint that allows you to bend and straighten your leg.

## Knee Disease

The most common reason for joint replacement surgery is **OSTEOARTHRITIS**. Osteoarthritis results in the break-down of cartilage on the ends of the bones. It usually appears in the joints that carry your body weight, such as hips and knees. Osteoarthritis can cause joint pain and stiffness that may require joint replacement surgery.

Other disease conditions may also damage the joint, requiring joint replacement surgery. These include rheumatoid arthritis or an injury to the joint. Talk to your doctor if you have questions about your joint health.

## Knee Replacement Surgery

In total knee replacement surgery, the surgeon replaces the diseased joint with an artificial joint (prosthesis). First, the surgeon makes an incision and moves the muscles and ligaments away from the knee joint. Then the damaged bones are reshaped to fit the artificial joint. The ends of the thigh bone and shin bone are covered with metal shells separated by a plastic liner. If the kneecap (patella) is damaged, it may be lined with a plastic disc. Once the new joint is in place, the muscles and ligaments are repaired. Your skin is closed with stitches or staples (staples are metal clips that hold your skin together while the incision heals). This surgery takes about one and a half hours.

Today, many patients who have knee replacement surgery can move their joint better, have less pain and are able to walk more comfortably for up to 25 years after surgery.

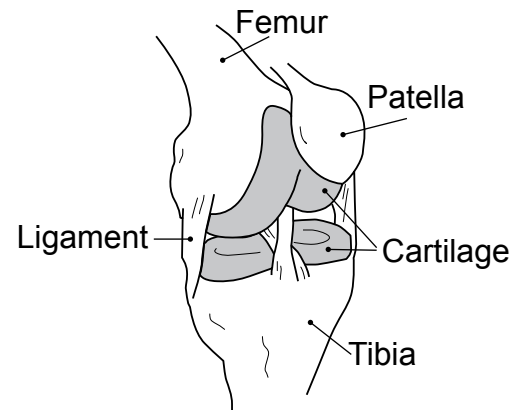

**Normal Knee Joint**

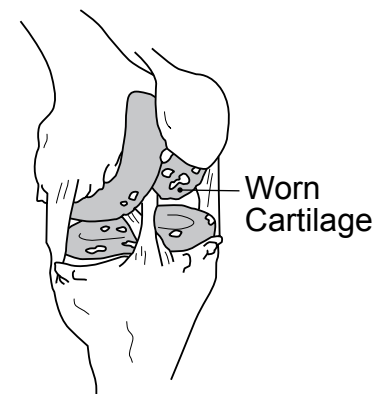

**Osteoarthritic Knee Joint**

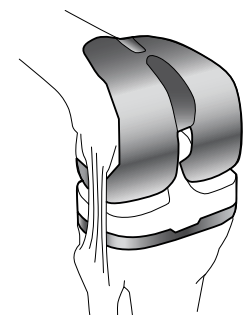
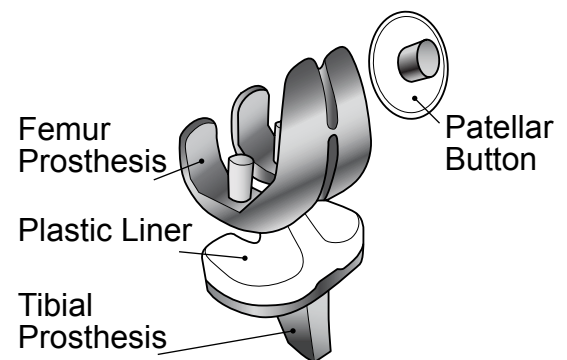

**Artificial Knee Joint**

## **Bilateral (Both) Knee Replacement**

In some cases, a surgeon may decide that both knees need to be replaced at the same time. This depends on a number of factors including your overall health, joint damage and lifestyle. The surgery will be the same as a total knee replacement. Your hospital stay may be longer and you may need more rehabilitation after surgery to help you get back to your daily activities.

## **Unicompartmental (Partial) Knee Replacement**

If you only have bone damage on one side of your knee, your surgeon may decide that you are a suitable candidate for partial knee replacement surgery. As with total knee replacement surgery, the surgeon reshapes the damaged parts of the bone to fit the artificial joint (prosthesis). Many people who have this kind of joint replacement surgery recover more quickly than people who have total knee replacement surgery. People who have partial knee replacement surgery are often sent home from the hospital the day after surgery.

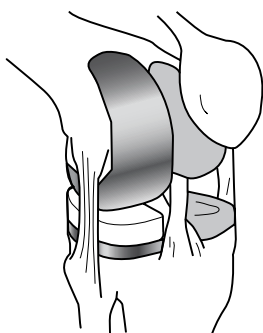

**Partial Artificial  
Knee Joint**

## **Knee Revision (Repeat)**

Some people who have had a knee replacement need another surgery. This can be because:

- Your new joint is loose or worn out
- You had bone loss or an infection in the joint

These surgeries can be more complex and you may need more rehabilitation. Compared to your first surgery, you may not be able to carry as much weight on your new joint while you recover.

## **Joint Components (Prostheses)**

Artificial knee joint components are made of medical-grade metal and plastic. There can be differences in the anatomy of men's knees and women's knees. Your surgeon may choose a "gender-specific" knee joint for you, depending on the shape of your knee.

## **Joint Attachment (Fixation)**

The artificial joint can be secured in different ways:

**CEMENTED:** The artificial joint pieces are secured to the bone with a quick-hardening adhesive material.

**CEMENTLESS:** The artificial joint pieces are closely fitted into the bones. These pieces are covered in a rough material that encourages bone growth. Bone growth into the artificial joint can provide additional long-term joint stability. Some parts of the artificial joint may be screwed in place to keep the joint stable.

**HYBRID:** A combination of these methods.

## Knee Precautions

**After Knee Surgery, you will need to follow KNEE PRECAUTIONS for 6 WEEKS unless otherwise advised by your surgeon.** These activity restrictions will help your joint to heal and reduce stiffness in the new joint. See “Complications” section for more information, page 58.

*Shaded leg is the surgical leg.*

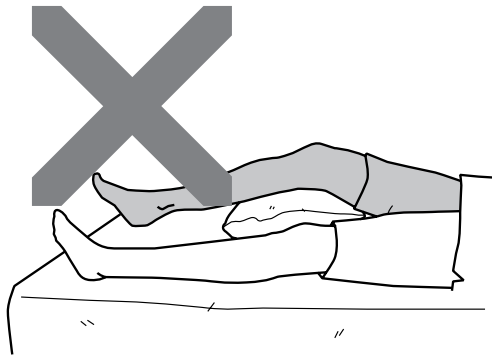

**DO NOT** put a pillow behind your knee. Your knee may become stiff if you keep it bent.

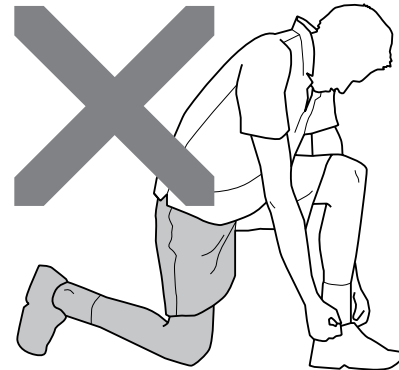

**DO NOT** kneel on your new knee joint

**DO NOT** do deep squats (squatting down to the floor.)

**DO NOT** carry heavy loads (e.g. more than 10 pounds.)

Additional Notes for Knee Surgery and Precautions:

---

---

---

---

---

---

---

---

Please consider moving objects in low cupboards to the counter top before surgery. Use caution when loading a wood stove or carrying heavy objects (e.g. groceries or small children)



**Things that you CAN DO after knee surgery:**

**Depending on your height, you MAY need to sit on a raised chair or use a cushion.** It will be easier to get on and off higher surfaces after surgery. Consider using a raised toilet seat.

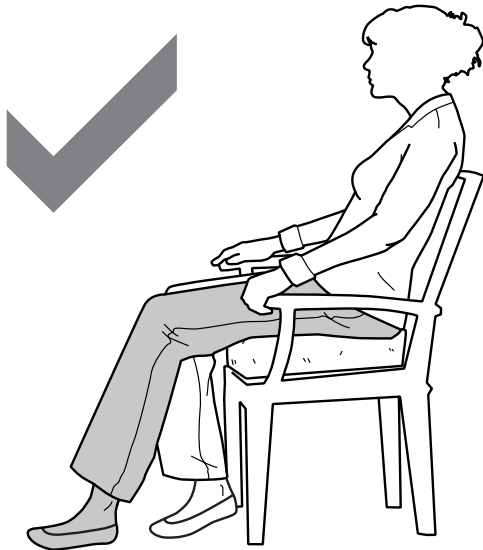

**You MAY need to use long-handled aids, like a shoehorn and reacher, to help you get dressed or pick up items.”**

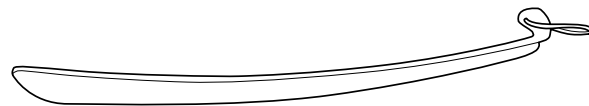
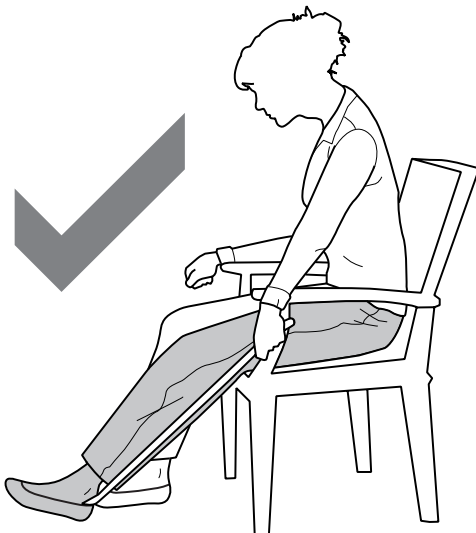

**Shoehorn**

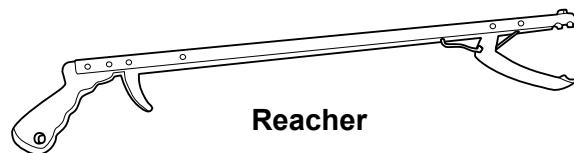

**Reacher**

# Before Surgery

In this section, you will learn about:

- Home Set-up
- Exercise
- Nutrition
- Pre-Operative Education
- Pre-Admission Clinic
- Final Checklist Before Surgery

## Home Set-Up

It is important to set up your home BEFORE joint surgery. This will allow you to easily move around your home with a walker or crutches after surgery, reduce the risk of falls and maintain your hip or knee joint precautions.

- Ensure hallways and rooms are free of clutter and tripping hazards (e.g. scatter rugs, footstools, etc.)
- Add non-slip surfaces to outside stairs and walkways in warmer months
- Arrange snow or ice removal of outside stairs and walkways in winter months before you return from the hospital and while you recover
- Install stair railings or make sure the existing ones are secure
- Set up a firm chair with armrests.
- Ensure good lighting in hallways and other well used areas during the day and night (e.g. night lights)
- Arrange for extra help with household tasks if needed (e.g. vacuuming, laundry)
- Move frequently used household items to counter height (e.g. pots and pans). Consider moving items in the lower parts of the fridge/ freezer to a higher shelf.
- Stock your freezer/pantry with healthy foods and snacks. If needed, private food/meal delivery services are available in many areas.
- Ensure an adequate stock of wood if used for heating. Assistance will need to be arranged if wood stove is not on main (living) floor of home.
- Keep an ice pack in your freezer for possible joint swelling after surgery. Alternatively, you can use a bag of frozen peas.
- Have a thermometer at home to check your temperature if needed after surgery.
- Arrange to have someone with you for the first 72 hours after you leave the hospital.

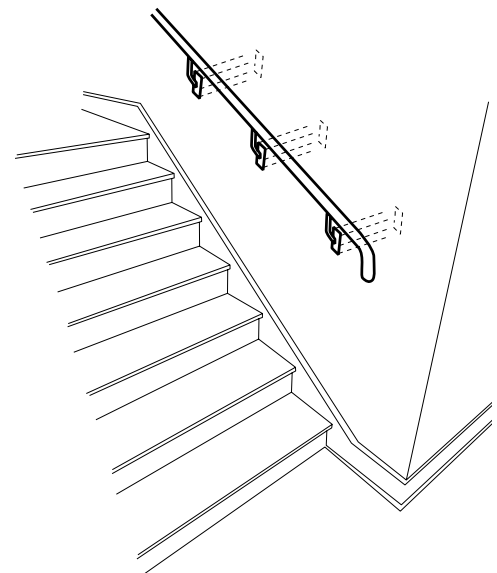

**Secure Stair Rails**

## Bathroom

- Install a raised toilet seat with armrests/toilet safety frame to assist you to sit or stand
- Remove sliding doors from your bathtub and replace with a shower curtain
- Set up a tub transfer bench (in the bathtub) or a shower chair (in a shower stall) **Do not use a regular stool or garden chair.**
- Use a non-slip bathmat both inside and outside the bathtub or shower
- Install a hand-held shower hose in the bathtub
- Grab bars in the bathtub/shower stall and by the toilet are very useful. Removable grab bars are available. Do NOT use towel racks or toilet paper holders to assist you to stand or sit.

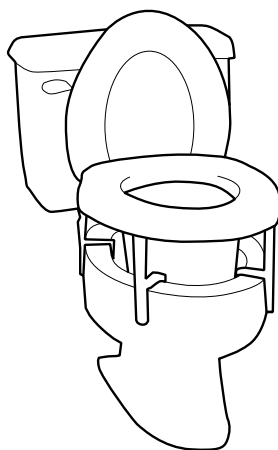

**Raised Toilet Seat**

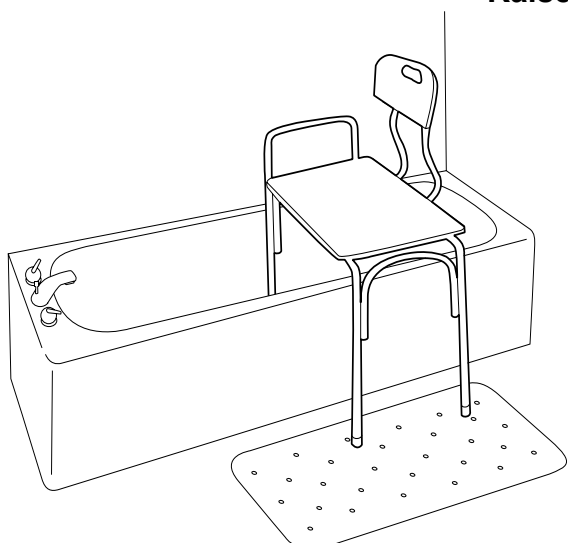

**Tub Transfer Bench**

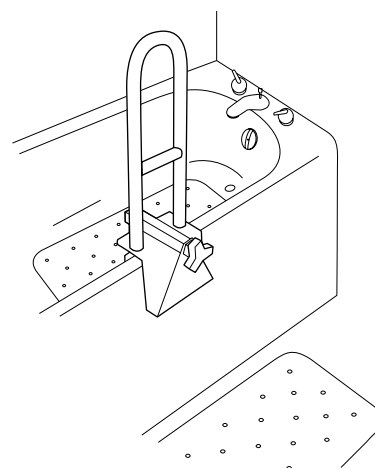

**Removable Tub Clamp**

## Seating After HIP SURGERY:

- As you are not able to bend your hip past 90 degrees for 3 months after hip surgery, **ALL** surfaces that you sit on **MUST** be 2 inches above knee height. This includes chairs, beds and toilets.

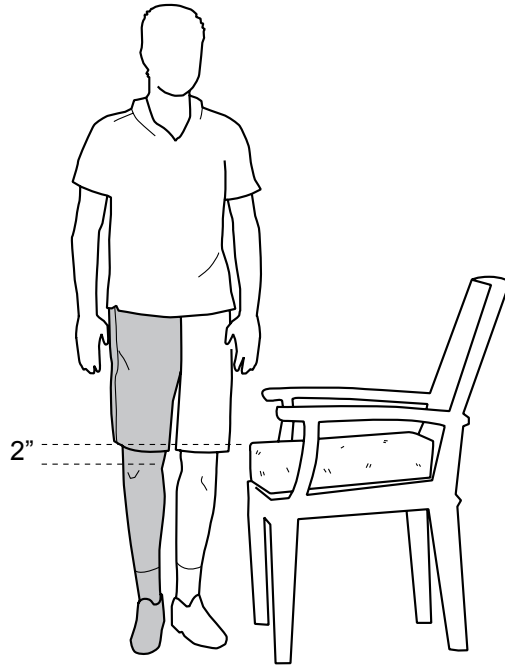

- Use a high-density (firm) foam cushion or bed blocks to increase chair height. The cushion should be firm enough that it will not compress when you sit on it. Plan to take your foam cushion with you to adapt chairs outside of the house.
- Set up a firm chair with armrests (not a rocking chair).
- Set up a table beside your chair for frequently used items as you will not be able to bend forward to the coffee table.
- If your bed is too low, add another mattress or place the frame on bed blocks.

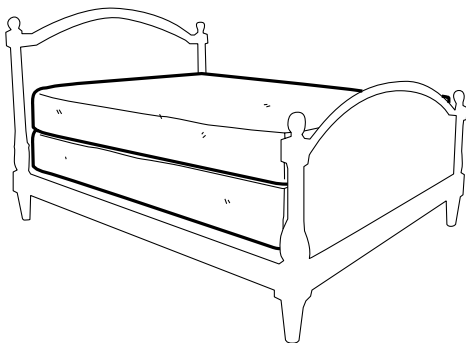

**Extra Mattress**

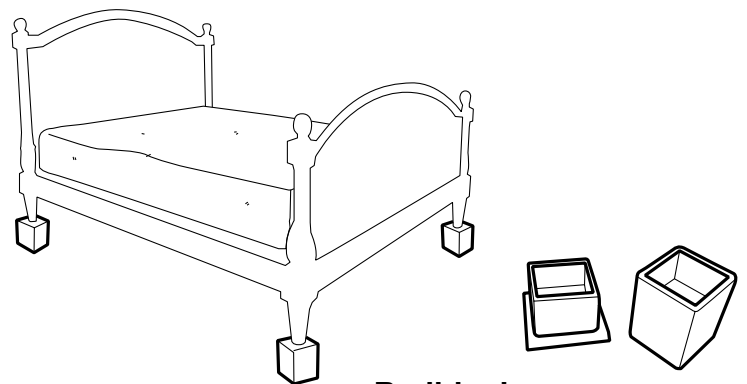

**Bedblocks**

**Equipment List – Arrange up to 1 week before surgery.**

<b>Equipment you MUST bring to HOSPITAL — unless otherwise told</b>	
<p><b>Hip Surgery</b></p> <ul style="list-style-type: none"> <li>• Walker                             <ul style="list-style-type: none"> <li><input type="checkbox"/> Standard OR</li> <li><input type="checkbox"/> 2-wheeled</li> </ul> </li> <li>• Crutches</li> <li>• High-density (firm) foam cushion* (at least 4 inch x 16 inch x 18 inch, needed for going home in the car)</li> <li>• Dressing equipment (long handled reacher, long handled shoe horn and sock aid)</li> </ul>	<p><b>Knee Surgery</b></p> <ul style="list-style-type: none"> <li>• Walker                             <ul style="list-style-type: none"> <li><input type="checkbox"/> Standard OR <input type="checkbox"/> 2-wheeled</li> </ul> </li> <li>• Crutches</li> <li>• Dressing equipment (long handled reacher, long handled shoe horn and sock aid) – OPTIONAL but recommended</li> </ul>

<b>Equipment for HOME</b>	
<p><b>Hip Surgery</b></p> <p>The equipment below is <b>REQUIRED</b></p>	<p><b>Knee Surgery</b></p> <p>The equipment below is recommended</p>
<ul style="list-style-type: none"> <li>• Raised toilet seat and safety frame (armrests optional)</li> <li>• Long-handled reacher</li> <li>• Long-handled shoehorn</li> <li>• Sock aid</li> <li>• Long-handled sponge*</li> <li>• Non-slip bathmat*</li> <li>• Elastic shoe laces* or use slip-on shoes with an enclosed heel</li> <li>• Hand-held shower hose*</li> </ul>	
<p>Bathing – use a <b>walk-in shower:</b></p> <ul style="list-style-type: none"> <li><input type="checkbox"/> Shower chair</li> </ul>	<p>OR <b>bathtub:</b></p> <ul style="list-style-type: none"> <li><input type="checkbox"/> Tub transfer bench OR</li> <li><input type="checkbox"/> Bath board</li> <li><input type="checkbox"/> Removable tub clamp</li> <li>OR installed grab bars*</li> </ul>

## Where to Get Equipment

### Red Cross Loan Cupboards

- Locations throughout BC
- Provides “free” equipment for 3 months (donations gratefully accepted)
- **REQUIRES a signed equipment request form.** This form will be provided by the hospital, at your hospital Pre-Operative Education class or through your community therapist. If you do not have this form less than 1 week before surgery, please contact your local hospital.
- Be aware that The Red Cross has a limited supply of equipment and may not have all the items you need.

### Medical Supply Store

- Equipment for rent and/or purchase
- May deliver to your home and/or install
- Costs may be covered by extended health plans – check your plan

### Equipment Funding Sources

(please tell the Occupational Therapist if you qualify)

- Department of Veterans Affairs (DVA)
- Work Safe BC
- ICBC
- Non-insured Health Benefits
- Local Band Office

### Friends/Family

Check with friends and family who may have equipment you can borrow

### Transportation Support

Some transportation support services require application forms to be completed by you and your doctor or health professional. These services include temporary disabled parking passes (SPARC pass) and HandyDart.

*For more information on the services listed above, see the Resources section of this booklet, page 63.*

## Exercise Before Surgery

Exercising before surgery will help you have a faster and easier recovery and **may help reduce your pain and improve your physical functioning while you wait**. Exercise may also improve your recovery time after surgery. However, please avoid any exercises that involve jumping or twisting; choose activities that put less stress on your joints.

Regular exercise will keep your muscles strong, your joints flexible and your cartilage well nourished. Some suggested exercise tips are:

- **Water Exercise:** Water based exercises, such as swimming or water walking at a community pool, reduce the load on your joints. Pool based exercise may also cause less pain immediately after the exercise session.

Remember to:

- Submerge the body part being exercised
  - Move your body slowly and smoothly
  - Stand straight and hold to the wall if you need support
  - Do not force movement—stop if you feel sudden or increased pain
  - Start slowly and progress your exercises gradually
- **Land Exercise:**
    - Walking as able with shoes that have good support. Remember the “2 hour pain rule”—if your joints hurt for longer than two hours after your walk, you have done too much. Manage the pain as able and walk a bit less the next day.
    - Walking with an aid, such as a cane or walking poles on level ground. A walking aid reduced the force on your hips and knees by up to 40% and may help you walk further with less pain.
    - Easy cycling. Cycling on a stationary bike is a great low impact exercise.
  - **Gentle stretching and strengthening.** Stretching will keep your joints flexible and strengthening will help build stronger muscles to better support the joints.
  - **Balance exercises.** Improving your balance is valuable in preventing falls.



**Strength and Balance Exercise can prevent falls!** By spending 3 hours a week doing exercises that increase your strength and balance, you will reduce your risk of a fall that could result in an injury. Connect with your primary care provider before and after surgery for exercises, such as Tai Chi, and visit [www.FindingBalanceBC.ca](http://www.FindingBalanceBC.ca) to learn more on how to reduce your risk of falling.

Remember to warm up before exercise and cool down afterwards; consult a physiotherapist for specific exercise advice. Choose activities you enjoy and look forward to doing. Making plans to be active with a friend or joining an exercise class can also help make exercising more fun!

These activities will strengthen your muscles, improve your endurance and help keep your joint moving. Exercising before surgery will also help you to build up your confidence and knowledge of how to exercise after surgery.

One example of an important exercise: Be sure to strengthen your arm muscles. You will need strong arms after your surgery to use walking aids, get in and out of bed, and get on and off a chair. If possible, do strengthening exercises for at least 3 weeks before surgery.

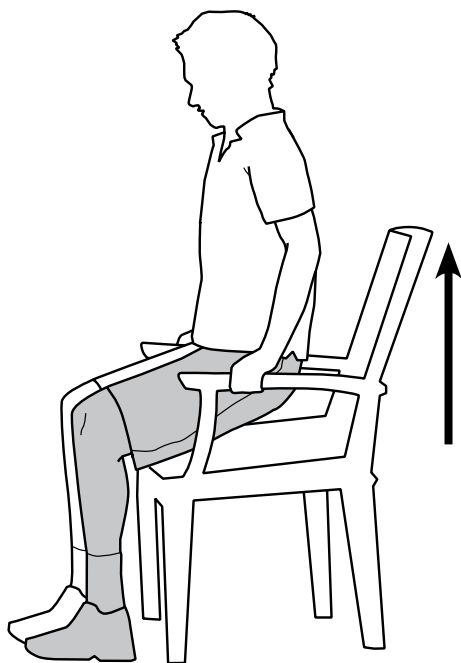

For example: Push up through your arms while seated. Work up to 10 repetitions 2 times each day.

If this exercise causes you discomfort, or if you are new to exercise and/or have other health conditions, always talk to your family doctor before starting a new exercise program. If you don't know how to get started, talk to a physiotherapist. You can also call **Physical Activity Services at Healthlink BC**, a service that is delivered Monday to Friday from 9 a.m. to 5 p.m. (PT) with translation services in over 130 languages. Educating yourself about exercise programs available to you before your surgery will help improve your activity.

**IMPORTANT TIP:** There are more great examples of exercises that can be found in the “Exercise Guide for Hip Replacement Surgery” and “Exercise Guide for Knee Replacement Surgery.” Ask your surgeon, family doctor or surgical services team for a copy!

## Nutrition Before Surgery

Eating well before and after surgery will promote recovery and reduce the risk of infection. A balanced and nutritionally adequate diet may help with wound healing, decrease hospital stay, and reduce complications from surgery.

Choosing food from the three food groups of the **Canada Food Guide** (<https://food-guide.canada.ca/en/>) will help you get the nutrition you need. These three food groups include:

- Vegetables and fruits—such as fresh, frozen, canned or dried fruits and fresh, frozen or canned vegetables
- Whole grain foods—such as whole grain cereal, whole grain pasta, whole grain brown or wild rice, quinoa, barley, whole oats, and whole grain bread
- Protein foods—such as beans, peas, lentils, peanut butter, nuts, tofu, eggs, fish, shellfish, meats, poultry, cheese, yogurt, unsweetened cow’s milk and fortified unsweetened soy beverage

Nutritionally balanced meals ideally include a variety of choices from the three food groups and snacks include choices from two of the food groups. Health Canada recommends balancing your plate to include  $\frac{1}{2}$  vegetables and fruit,  $\frac{1}{4}$  whole grain foods, and  $\frac{1}{4}$  protein foods.

Here are some meal and snack ideas:

Breakfast	<ul style="list-style-type: none"><li>• Whole grain cereal with milk and orange sections</li><li>• Fruit, yogurt and granola parfait</li><li>• Whole grain bread with peanut butter and banana slices</li><li>• Scrambled egg with beans, peppers, cheese, and salsa in a whole grain tortilla</li><li>• Fruit and yogurt smoothie and a wholegrain muffin</li></ul>
Lunch	<ul style="list-style-type: none"><li>• Hummus with whole wheat pita, carrot sticks, and pepper slices</li><li>• Vegetable and bean soup and a grilled cheese sandwich</li><li>• Hawaiian pizza and veggies and dip</li><li>• Salmon salad sandwich and fruit salad with yogurt</li></ul>

Dinner	<ul style="list-style-type: none"> <li>• Baked beans, green salad with dressing, and a whole grain bun with non-hydrogenated margarine</li> <li>• Mixed bean and beef chili served over brown rice and topped with grated cheese</li> <li>• Pork and green bean stir-fry served over whole-wheat couscous and topped with chopped peanuts</li> <li>• Baked fish, roasted vegetables, and brown rice</li> </ul>
Snack	<ul style="list-style-type: none"> <li>• Carrot sticks and hardboiled egg</li> <li>• Celery sticks and peanut butter</li> <li>• Homemade trail mix of dried apricots and almonds</li> <li>• Apple and cheese slices</li> <li>• Whole grain cereal and milk</li> </ul>

Fat adds flavour and satisfaction to your meals and snacks. Choose unsaturated fats more often, instead of saturated fats. Sources of unsaturated fats include nuts, seeds, avocado, fatty fish (e.g. trout, salmon, herring and mackerel), vegetable oils (e.g. canola, corn, flaxseed, olive, peanut, safflower, sesame, soybean, sunflower), and soft, non-hydrogenated margarines.

Consider stocking up your freezer and cupboards before going to the hospital so that you have food to eat when you return home. There are other supports that could help with having food on hand: family or friends, online shopping, grocery delivery, or meals on wheels may be a few options for you.

**Special Considerations**

**Protein**

Protein promotes healing after surgery. Most people get enough protein from the food they eat and do not require a supplement. The protein foods group from Canada’s Food Guide provides protein, vitamins and minerals. Include a variety of protein foods in your meal planning, with a focus on plant-based proteins.

Examples include:

- beans, peas, lentils or tofu
- nut butter (e.g. peanut, almond, cashew)
- nuts or seeds
- eggs
- beef, lamb, pork, poultry, wild game, fish or shellfish
- unsweetened cow’s milk or unsweetened fortified soy beverage
- yogurt
- cheese

## Iron

Iron is a mineral that is important for your health. Iron can be found in many foods including meats such as beef, chicken, pork, turkey and wild game, fish and seafood, beans, peas and lentils, blackstrap molasses, grains, eggs, and in some vegetables such as asparagus, seaweed, and spinach. There are two types of iron:

- Heme iron is more easily absorbed than non-heme iron and can be found in fish, meat, and poultry
- Non-heme iron is what makes up most of the iron in our diet and can be found in eggs, grains, dried fruits, and vegetables. This type of iron is not as well absorbed as heme iron. Your body will absorb more non-heme iron if you eat foods that are high in vitamin C at the same meal or snack. Vitamin C can be found in foods such as oranges, strawberries, kiwi, sweet peppers, and broccoli.

Low iron levels could slow your recovery. Check out **Health File 68d: Iron in Foods** (<https://www.healthlinkbc.ca/hlbc/files/documents/healthfiles/hfile68d.pdf>) for more information. Talk to your healthcare team if you need help optimizing your iron levels.

## Calcium

Calcium is a mineral that helps you build and maintain strong bones and teeth. Your daily need for calcium depends on your age:

- 19-50 years: 1000 mg/day
- 51+ years: 1200 mg/day for women and 1000 mg/day for men

Food sources of calcium include:

- *Protein foods:*
  - milk, yogurt, cheese
  - canned fish with bones (e.g. salmon, sardines)
  - almonds, beans, lentils
- *Vegetables and fruit:* collard greens, cooked spinach, fortified orange juice
- *Other:* blackstrap molasses

## Vitamin D

Vitamin D is a fat-soluble vitamin that helps your body absorb and use calcium and phosphorus for strong bones and teeth. Vitamin D also helps protect against infections. Your daily requirement for vitamin D is dependent on your age:

- 19-70 years: 600 IU
- 71 + years: 800 IU

As well, Health Canada recommends that all Canadians over the age of 50 years should take a daily supplement of 400 IU of vitamin D, along with eating sources of Vitamin D from Canada's Food Guide.

Food sources of vitamin D:

- *Protein foods:*
  - fatty fish (e.g. salmon, mackerel)
  - milk
  - fortified soy beverages
- *Vegetables and fruit:* fortified juice
- *Other:* margarine

Non-Food Sources: vitamin D is known as the “sunshine vitamin” as it is made when the sun's rays interact with the skin. In Canada, we are only able to make vitamin D from the sun between May and October. Balance sun safety with the need for vitamin D.

See **Health File 68e Food Sources of Calcium and Vitamin D** (<https://www.healthlinkbc.ca/hlbc/files/documents/healthfiles/hfile68e.pdf>) for more information. Talk to your Doctor, Registered Dietitian or Pharmacist about Vitamin D supplementation.

## **Multivitamin**

While a basic multivitamin is not a replacement for a healthy diet, it could help to promote healing. Remember that large doses of any nutrient are generally not recommended. Talk to your Doctor, Registered Dietitian or Pharmacist about supplementation.

## **Fibre, Fluid and Regularity**

Regular bowel movements are an important part of health and are key before joint surgery as constipation can be a complication of surgery. Regular bowel movements do not need to occur daily. What is key is that the stool is soft and can be passed without straining or discomfort. If you have small, hard stools that are difficult to pass, you may be constipated. To support regular bowel movements:

- Eat enough food.
- Include a variety of fibre-rich foods in your diet. Examples of fiber-rich food includes 100% whole grain breads, cereals, and crackers, fruits, vegetables, beans, and lentils. Eat fibre rich foods throughout the day at meals and snacks. See **Health File 68h Fibre and Your Health** (<https://www.healthlinkbc.ca/sites/hlbcprox-prod.health.gov.bc.ca/files/documents/healthfiles/hfile68h.pdf>) for more information on food sources of fibre.

- Drink plenty of fluid throughout the day. Make water your drink of choice. Other options include unsweetened milk (2%, 1%, or skim), unsweetened fortified soy beverage, and unsweetened coffee and tea.
- Be active within your physical capabilities.

You should see your doctor if:

- There are sudden changes in your bowel habits.
- You have been constipated for some time and dietary changes do not seem to help.

## Health and Weight

Lack of adequate nutrition stores may negatively affect your recovery from surgery. While there is some view that moderate weight loss may help to reduce hip and/or knee pain, it is also recognized that the pursuit of weight loss may compromise your ability to eat enough quality food to support overall health. Weight is not as easy to influence as one would think. What can be influenced are the choices you make regarding eating, movement, and rest to care for your body. Trust that changes here will help your body get to the weight that is best for it.

The previous section described what to eat. Just as important is consideration of how you approach eating. Here are a few tips to support you to eat well and achieve your best weight:

- Enjoy regular meals and sit-down snacks every day.
- Plan for healthy eating: create a weekly menu, build and follow a grocery list, and use food labels. Include a variety of foods (types, tastes, textures, temperatures and cooking methods) in your menu planning.
- Cook at home more often, using foods from Canada's food guide in your recipes.

Practice mindful eating: trust your body's cues to know when you are hungry, how much to eat and when to finish a meal or snack. Enjoy your food. Recognize that how much you eat may vary from day to day.

## Referral

In BC you can reach a Dietitian by calling HealthLinkBC at 811 or visiting [www.healthlinkbc.ca/dietitian/](http://www.healthlinkbc.ca/dietitian/). You can also get a referral to a Registered Dietitian through your health authority. For more information on healthy eating and nutrition visit the Dietitians of Canada website [www.dietitians.ca](http://www.dietitians.ca). Remember to always clarify any questions you may have about your nutrition with your health care team.



## Mental Health and Wellness Before Surgery

Mental Wellness is an important part of your preparation before surgery. Mental health includes our social, emotional, psychological and spiritual well being. Mental health affects how we think, feel, and act. It helps determine how we handle stress and make choices. It is an important part of our life. It is important to be aware of the various aspects of our mental health. You may experience a range of emotions, feelings and thoughts about your surgery which is common and expected. Hip and knee pain can also contribute to those feelings and a successful surgery can offer an excellent chance to improve from those feelings. Understanding and being able to manage feelings of worry, sadness, anxiety or any other feeling you notice before surgery will you have a faster and easier recovery. Being able to recognize racing thoughts, all or nothing thinking or other common thought traps is essential to re-framing your thinking to more positive and realistic track. A positive mood will help reduce your chances of medical or surgical complications in the short and long-term.

All efforts need to be invested to create a positive and hopeful mood. Taking time to enhance and care for your mental health will contribute to successful health outcomes such as minimizing complications from surgery. Expect the unexpected. You may experience a wide variety of emotions, thoughts and feelings before, during and after surgery. Keep your self-care tools handy to help along the way (i.e. music, art, journaling, yoga, talking, reading etc.).

Some helpful tips may include:

- **Identify the emotion:** stress can be hard to recognize, step back and evaluate—are you clenching your teeth? Is your stomach upset?
- **Manage your mood:** take ownership of your ability to manage your health issues
- **Connect with people:** build confidence, connect with friends, support groups, neighbours or even animals that bring you comfort and joy
- **Feed your body to feed your mind:** feed yourself faithfully to support energy and mood regulation. Enjoying a variety of foods from all four food groups of Canada's Food Guide as planned meals and sit-down snacks will support you to get the nutrients you need!
- **Drink well:** make water your primary beverage, especially between meals. If you are having difficulty with sleep, consider how much caffeine you consume through beverages (e.g. coffee, tea, hot chocolate, energy drinks, cola) and food (chocolate) and make changes as necessary.



- **Work it out:** it may be hard to exercise but even mild forms that are recommended by your health care provider team while you wait for your surgery can help release feel-good brain chemicals; every move counts!
- **Quiet your mind:** consider meditation or breathing exercise that have been shown to ease pain, anxiety, and depression.
- **Sleep well:** sleep is important for your well-being. Your body and mind need to rest. Enjoy caffeine in the morning, avoid naps during the day, put down your electronics an hour before bed, try to get to bed at the same time each night, and keep your room and a cool and comfortable climate to get the best rest you can.
- **Talk to a health care provider:** if you have low spirits for more than two weeks or your mood is interfering with your daily life, relationships, or job, it's time to check in with a health care provider such as a doctor, nurse, counselor or social worker to see what your next steps are.
- **Substance use:** talk to your health care professional about ways to reduce risks from any substances that are part of your life. Substances such as, but not limited to, tobacco, alcohol, cannabis, prescription and over the counter medications may interact with your procedure and recovery. It is important to let your family doctor or surgeon know if you are taking any substances so that you can plan ahead to reduce risks and enhance health.

**Educating yourself about the surgery can also help reduce anxiety and fear about the procedure.** Take time to ask your health care team any questions you may have about the procedure, what to expect after the procedure, what to expect when you get home, or any general questions that you may have.

**Goal setting may help empower you to make healthy choices.** As you progress through your journey, remember to make reminders or set goals for yourself to help you identify where you are now compared to where you would like to be. Remember to create **SMART GOALS: S-Specific, M-Measurable, A-Action based, R-Realistic, T-Timely.**

For example: “I’m going to connect with a friend” is NOT a SMART goal because there is no time-line attached and you are never able to say that the goal has been completed. Instead, a SMART goal around exercise might look like this: “I am going to walk around the park for 15 minutes, 3 times this week with my significant other”. The goal outlines a specific activity within a specific amount of time. Once you have finished, you can check it off your list and set a new goal for yourself!

Some goal setting tips:

- **Write your goals down** – use a journal or a calendar to keep track
- **Share your goals** with family and friends
- **Review your goals** regularly then set new SMART goals as you progress
- **Have a back-up plan.** For example, if you can't exercise outside, consider walking in a mall
- **Reward yourself!** Once you achieve your SMART goal, recognize that and give yourself small rewards.

If you notice or have concerns around your mental health and well being or have questions about your procedure, it is important to take the time to discuss it with your health care providers, such as your surgeon, family doctor, or surgical services team. Healthlink BC can be called at **310-6789 (no area code needed)** for emotional support, information, and resources specific to mental health. Everyone has mental health and everyone can enhance their mental health. Take time to be intentional with your mental wellness for the best possible surgery outcomes.

## Stop Smoking Before Surgery

As we all know, smoking is bad for your health and also affects the people around you when they are exposed to second hand smoke. You may be concerned about your surgery and wondering what you can do to get ready, but rest assured, you can improve your surgical outcome if you stop smoking.

Studies have shown that stopping smoking **at least 4 weeks** before surgery can:

- Reduce the risk of complications during and after surgery
- Reduce the chance of infection
- Reduce the time it takes to heal from surgery
- Reduce the chance of a serious heart and/ or lung complication
- Reduce bone healing

Counselling and the use of nicotine replacement therapy can improve your odds of quitting. Studies have shown that a major surgery is a great motivator and can increase your likelihood of stopping smoking!

## What Resources Are Available to Stop Smoking?

The B.C Smoking Cessation Program helps eligible B.C. residents who wish to stop smoking or using other tobacco products by:

- Covering 100% of the cost of nicotine replacement therapy products which include:
  - Nicotine gum
  - Nicotine lozenge
  - Nicotine patch
  - Nicotine inhaler
- Contributing to the cost of specific smoking cessation prescription drugs (i.e. bupropion—brand name Zyban, varenicline—brand name Champix). Not everyone is eligible for smoking cessation prescription drugs, check with your pharmacist about coverage.

Each calendar year, eligible B.C. residents can receive a single continuous course of treatment (up to 12 weeks or 84 days in a row) with nicotine replacement therapy or smoking cessation prescription drugs. **Simply speak with your local pharmacist to get started!** You can also talk with your surgeon, family doctor, local pharmacist, or any other healthcare provider in your circle of care about these options.

If you need more support outside your circle of healthcare providers, **HealthLink BC**, your provincial health line, can be reached by phone or web any time of the day or night, every day of the year. Call **8-1-1** toll-free in B.C. or for deaf and hearing-impaired, call 7-1-1. You can speak with a health service navigator, who can also connect you with a registered nurse or pharmacist. Translation services are available in more than 130 languages.

**QuitNow BC** also offers support toll free phone or video conferencing. By calling toll-free number at **1-877-455-2233** you can access your own personal Quit Coach that can help with your journey to quit smoking. You can have a one-off conversation or a series of calls where a Quit Coach can walk you through the full process of quitting smoking. This support line is offered to anyone, including healthcare providers and family members, looking for answers to specific smoking-related questions.

In addition to the resources listed above, here are some more tips to successfully stop smoking:

- **Pick a date:** pick a date within a month from now and stick to it! Make sure you give yourself long enough time to prepare but don't wait so long that you change your mind
- **Make a list:** aside from maximizing your surgery outcomes, think of all the other reasons that you want to be smoke-free and use them as motivators
- **Consider quitting aids:** consider medications and/ or use counselling to help you quit; if you use both, you can double your chances of quitting
- **Recruit a buddy:** find someone or some people that you can share your goals with and call them for support whenever you have cravings
- **Know your habits:** identify what triggers you to smoke and find ways to avoid it
- **Stock up on snacks:** veggies, pretzels, hard candies or other light snacks that you can chew on will keep your mouth and mind busy so you don't have cravings
- **Drink lots of water:** drinking water helps take away cravings
- **Treat yourself:** reward yourself with the money you've saved and recognize your milestones like one week smoke-free, one month smoke-free etc.
- **Keep trying:** quitting smoking is hard, learn from your setbacks and don't get discouraged!

**Remember that stopping smoking at any time is beneficial for your long-term health but trying to stop at least 4 weeks before surgery can maximize post-surgical outcomes.**

**Please note, Northern Health supports the cultural and ceremonial uses of tobacco and recognizes that the benefits of traditional uses can outweigh the potential harms.**

## Pre-Operative Education

You will be contacted with an appointment to see an orthopedic surgeon and to attend a Pre-Operative Education Session. At this session, you will learn more about your surgery, what to expect while you are in hospital and what you need to prepare at home. For more information on preparing for surgery, see *Resources on page 63*.

## Pre-Admission Clinic (PAC)

### WHEN? 2 -3 weeks before your surgery

The Pre-Admission Clinic will call you to schedule an appointment. This appointment will last 3-4 hours.

- Please dress comfortably and bring a small meal or snack if needed.
- We recommend you bring a family member or support person with you to this appointment
- Due to the length of the appointment and amount of walking involved we recommend you bring a “loonie” to access a wheelchair

The nurse will discuss many points including:

- When to stop eating and drinking before surgery
- Medicine management before and after surgery. **Some medicines and supplements must be stopped 1-2 weeks before surgery** to avoid problems with bleeding or sleepiness. Talk to your surgeon if you have questions about your medicines.
- Allergies

The occupational therapist will assist you with the following:

- A questionnaire to provide details on your home environment and support system
- Viewing a video on joint replacement
- Safely using equipment for the bathroom and dressing

**You will also receive your equipment referral at this time.**

**Bring ALL of your medicines/supplements to your Pre-Admission Clinic appointment.**

You may have some tests done including:

- Blood work
- X-ray
- ECG (electrocardiogram)

You may also be scheduled to meet with an anesthesiologist. This is a medical doctor who is trained to give anesthetic drugs and monitor you throughout your surgery.

**Your surgery may be cancelled if you have:** an active infection anywhere in your body, a skin infection over the joint, a cold or the flu. If you are sick before surgery, **call the Pre Admission Clinic at the hospital.**

## 1 Day Before Surgery: A FINAL Checklist

By now you should have picked up your medical equipment and set up your home. You should have arranged for someone to stay with you for the first 72 hours after you leave the hospital. Here is a final checklist of things you need to do before coming to the hospital:

- Label all of your equipment with your name (e.g. walker, crutches, dressing equipment) – if you are bringing these items to the hospital
- Make arrangements for transportation to and from the hospital
- Have a bath or shower using regular soap the night before, and/or the morning of your surgery (**do not** shave your legs as any cuts or skin irritation may result in your surgery being cancelled)
- Pack your bag for the hospital. Bring:
  - toiletry items (e.g. toothbrush, hair brush etc.)
  - loose fitting clothes to exercise in and to wear home
  - comfortable, closed toe and heel shoes/slippers with non-slip soles. Your shoes should be roomy since you will have some swelling in your feet.
  - if you wear elastic support stockings, bring them with you
  - eye glasses and reading materials
  - hearing aids
  - if needed, credit card information for items such as hospital TV rental

**DO NOT bring valuables to the hospital**

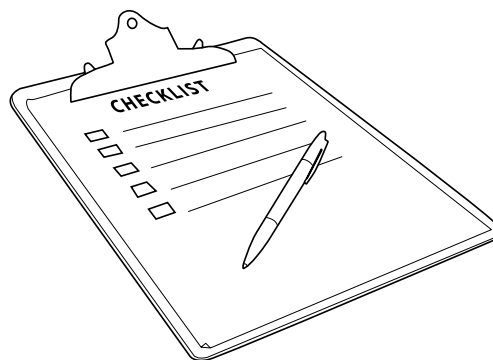



# During Your Hospital Stay

In this section, you will learn about:

- Day of Surgery
- Length of Hospital Stay
- Rehabilitation
- Pain Control
- Rivaroxaban
- Going Home

## Day of Surgery

### Before Surgery:

- Go to the Patient Registration Department in the hospital
- You will be directed to the Day Surgery Dept. to be prepared for surgery.
- Ask friends or family to bring your suitcase and labelled equipment to the hospital ward unless otherwise instructed

### During Surgery: Anesthesia

Each hospital manages your anesthetic differently. Many people who have joint replacement surgery have **spinal anesthetic**. This is like the freezing you get at the dentist, except this freezing goes into your back and makes you numb from the chest down and stops you from feeling pain. The anesthesiologist will make sure you are comfortable throughout the surgery, giving you medicine through your IV that makes you relaxed and sleepy. If you have a spinal anesthetic, you will not be able to move your legs for up to 4 hours after surgery.

Some people receive **general anesthetic** (sleeping). This is medication to make you completely lose consciousness so the surgery can be performed without causing pain or distress.

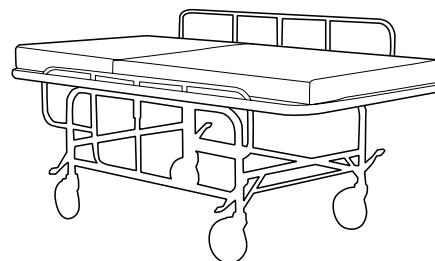

### After Surgery: Recovery Room

- You are moved from the operating room to the recovery room.
- You may have oxygen by mask for a short time or nasal oxygen overnight.
- The nurse monitors your vital signs, including your pulse and blood pressure.
- You will have pain medicine on a regular basis. **Tell your nurse if you are in pain.**
- The stay in the Recovery Room is usually 1 to 3 hours.

### After Surgery: The Hospital Ward

- Once you are medically stable, you are transferred to the orthopaedic ward
- You will be told how much weight you can put on your new joint (weight bearing status). This can vary for each individual. Often people are told to weight bear as tolerated, but you may have a weight-bearing restriction such as partial, feather, or non-weight bearing on your surgical leg
- The ward staff will help you to stand on your new joint if allowed by your surgeon

- The nurse will assess you for pain and nausea
- You will use a commode/raised toilet seat during the first day and night. When you are able, you will walk to the bathroom. Some people who have spinal anesthetic find it difficult to urinate and will need a catheter (a temporary tube placed in your bladder to empty it).
- You will have blood work done daily
- You may have an intravenous line (IV) for medicine
- After the surgery, you may have a drain on your leg to collect blood from your hip or knee
- You are taught exercises to help reduce complications after surgery, such as:
  - > breathing deeply and coughing every hour to keep your lungs clear
  - > pumping your ankles to improve circulation in your legs
- You may be started on a blood thinning medicine after surgery to help reduce your risk of developing a blood clot.

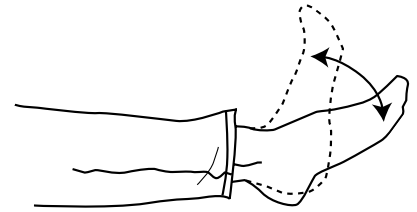

## Length of Hospital Stay Guidelines

Your time in the hospital is **short**. Your health care team will work with you to make sure you are medically stable and able to manage daily tasks to go home. Before surgery, it is important to make arrangements to have someone pick you up from the hospital when going home. **Discharge time is usually in the morning. Be aware that you may go home sooner than expected. Ensure your travel arrangements are flexible.**

<p><b>Total Hip Replacement = 1 - 2 nights</b> (includes resurfacing and revision surgery)</p> <p><b>Total Knee Replacement = 1 - 2 nights</b> (includes revision surgery)</p> <p><b>Partial Knee Replacement = overnight</b></p>
-------------------------------------------------------------------------------------------------------------------------------------------------------------------------------------------------------------------------------------------

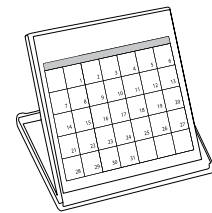

**For example:** If you have surgery on Monday and are spending 2 nights in the hospital, you will probably be sent home on Wednesday morning.

Monday	SURGERY DAY
Tuesday	
Wednesday	DISCHARGE HOME

## Rehabilitation

- **Physical activity is a very important part of your recovery.** Not only does it help to improve the function of your joint, but it also helps clear your lungs, reduces the risk of blood clots in your legs, reduces pain, and starts your bowels moving.
- The physiotherapist (PT) will work with you throughout your stay. Your physiotherapist will teach you how to:
  - > walk with a walker and/or crutches
  - > do your daily exercises
  - > use the stairs safely
- The physiotherapist will give you exercises to do in hospital and at home. They may also refer you to a physiotherapist in your local community.
- Your occupational therapist (OT) will teach you how to do daily activities such as dressing and bathing, and help you to use your equipment, while following precautions and protecting your new joint.

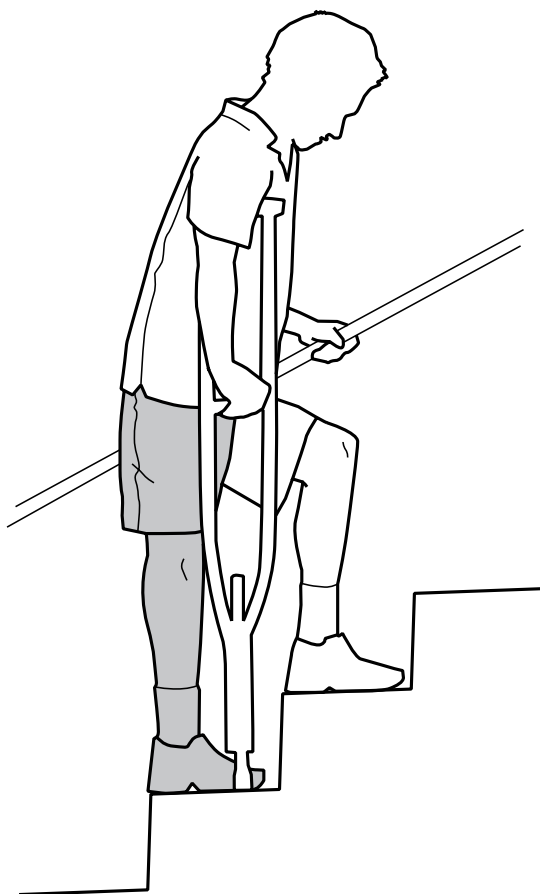

## Pain Control After Surgery

- Your nurse will teach you how to use the pain scale to describe your level of pain. “0” is no pain and “10” is the worst possible pain.

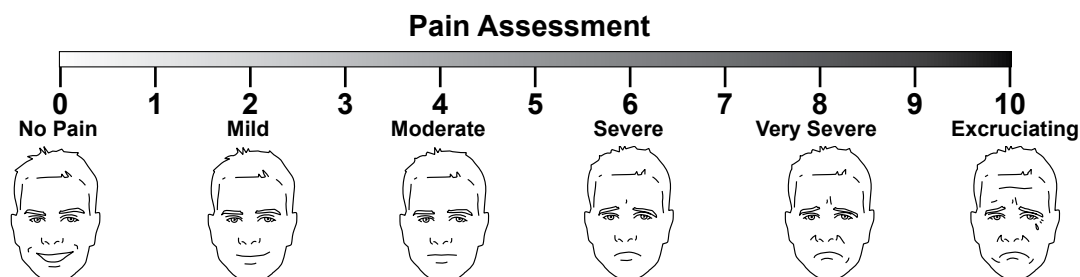

- It is our goal to keep your pain at “3-4” or below at all times.**
- Please expect some pain after surgery as complete absence of pain following surgery is unrealistic.
- Generally, pain medicine is given as a pill taken by mouth.
- If you have had a general anaesthetic, you may have a patient controlled analgesia (PCA) pump. This is when a controlled amount of pain medication is pumped into your IV tube when you push a button.
- Some side effects of pain medicine can include: nausea, vomiting, drowsiness, itchiness and/or constipation. Tell your nurse if you have any of these symptoms.
- Studies demonstrate that the risk of addiction is low when using opioids for acute pain. It is important to have adequate pain control to ensure a successful recovery from your surgery.

## Pain Control at Home

Most people have less and less pain over the next 6 to 12 weeks. If pain is preventing you from caring for yourself, sleeping and/or exercising, talk to your physiotherapist or doctor. **If your pain becomes increasingly worse OR if you have pain in a new part of your body, seek medical attention immediately.** (See page 64 of this booklet for guidelines).

Here are some ways to manage your pain:

- Take **pain medicine** as directed. It is normal to have some increased pain or symptoms during physical activity or physiotherapy sessions. It may be helpful to take a dose of pain medicine 1 or 2 hours before engaging in these activities in the first weeks after surgery. It is better to take medicine **BEFORE** the pain is severe.
- **Ice** can reduce pain and inflammation. It is particularly useful for people who have had knee replacement surgery. Place an ice pack wrapped in a towel on your joint as directed by your physiotherapist.
- **Pace yourself.** Do not push yourself. Regular rest is an important part of your healing process.
- **Relax.** Use relaxation techniques such as breathing exercises or progressive muscle relaxation (progressive muscle relaxation is when you tighten and relax each part of your body, starting with the toes and working up to your neck).
- **Distract** yourself. Listen to music, visit with friends, write letters, watch TV.
- **Think positively.** You will become more and more comfortable as you recover from your surgery.

## Anti-Coagulation

### Blood Thinners

After hip or knee replacement surgery, you are at risk for developing a blood clot (see “*Complications*”, page 58). Many people are given an oral medication called Rivaroxaban to reduce this risk. Your doctor will decide if this medicine is right for you.

Here is some information about Rivaroxaban:

- Blood thinner is given DAILY for 14 days after knee replacement surgery and 35 days after Hip Replacement Surgery
- Blood thinner is given at the same time each day
- The main pharmacies near city hospitals carry this medication. Pick up your prescription the day you are discharged from the hospital. If you are planning on using your local pharmacy, be aware that they may need 48 - 72 hours to get your medication in stock.
- The cost of blood thinners may differ depending on your PharmaCare deductible or if you have 3rd party coverage. Each pill costs about \$10.00

Some patient will receive injections under their skin while in hospital and given a blood thinner such as full dose Aspirin when they go home for the 14 or 35 day period for knees or hips respectively. Patients who are already on a blood thinner before surgery may have a different regime afterward.

### Going Home

Most people will be discharged **home**, not to a rehab facility. Before leaving the hospital, plan appointments with the following people:

#### Follow-Up Medical Appointments

- The person (e.g. family doctor or surgeon) who will remove your staples, 7-14 days after surgery
- Your surgeon, usually around 6 weeks after surgery
- Your physiotherapist, usually within 1 week of discharge (if recommended by your surgeon)
- Your family doctor, once you are back on your feet, to review your general condition

# After Surgery

In this section, you will learn about:

- Recovery at Home
- Everyday Activity Guidelines
- Returning to Work
- Complications
- Dental Work or Other Medical Procedures



## Recovery at Home

### Physiotherapy After Hospital

The hospital physiotherapist will tell you where you can obtain physiotherapy services when you get home from hospital. Depending on your needs, where you live and local services, your appointment may be at a physiotherapy clinic, out-patient hospital centre, rehab facility or home health program.

Your physiotherapist will give you exercises to stretch and strengthen your legs and improve your walking and balance. As you recover, the exercises will get harder. Doing the exercises assigned by your physiotherapist will help you move your new joint and enjoy greater independence. It is important to continue with the exercises for at least 1 year after your surgery.

Talk to your physiotherapist if you have questions about your exercises or concerns about your progress.

### Transportation

There are many different ways to get around after surgery. Here are some options:

- Friends / family
- Taxis
- Temporary disabled parking pass (SPARC)\*
- HandyDART\* (if available in your community) — transit service for those who cannot use the regular bus service. HandyDART will pick you up and drop you off at appointments such as medical visits.
- Travel Assistance Program (TAP)\*— assists with costs for out-of-town medical travel
- Northern Health Connections - travel for out-of-town medical appointments. Visit: [nhconnections.ca](http://nhconnections.ca)

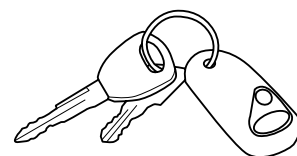

**Personal Vehicle**

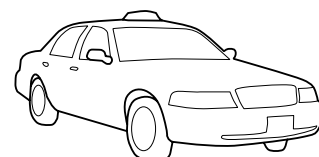

**Taxi**

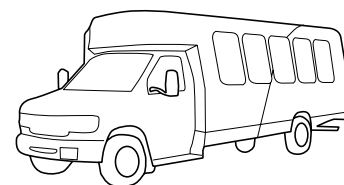

**HandyDART**

## **Air Travel**

You may have some extra challenges travelling by plane after surgery. Be sure to give yourself extra time when flying. Your new joint may set off metal detectors at the airport. If you are flying within 3 months of having hip surgery, bring your high-density foam cushion to raise the height of your seat. While on the plane, do foot pumping exercises every hour to help reduce the risk of clots. If flying home from hospital, check with your air carrier if medical documentation is needed.

For regular travel you will not need a note from your doctor stating that you have a joint replacement.

## **Driving**

Driving is restricted after knee or hip surgery. There are a number of factors that can impact your ability to safely return to driving. These include using mobility aids and taking prescription pain medicines. Talk to your surgeon and physiotherapist before driving. Most people can safely start to drive within 6-8 weeks after surgery.

## **Car Transfer**

It can be challenging to protect your joint getting into some cars, particularly following hip surgery. Please practice these instructions before you come to the hospital. If this is problematic, please ask your occupational therapist to help you.

- Park away from the sidewalk or curb so you are not stepping down from the curb to the car. If you have a high truck or sport-utility vehicle, you may need to park near the curb so that you do not have to climb up to the seat.
- Move the seat as far back as possible
- Recline the seat
- Place your high-density foam cushion on the seat. If it is a wedge cushion, position the thick end at the back of the seat.
- Back up to the seat until you feel the back of the seat on your legs
- Extend your operated leg
- Hold onto the back of the seat and the car to stabilize yourself

- Lower yourself to the seat
- Slide back and lift your legs into the car. (If you have had hip surgery, do NOT bend more than 90 degrees).
- A piece of plastic or a large garbage bag over the cushion may help you to slide in more easily
- You can also try a device called a “Handybar” that can assist you to get in and out of a regular car. This can be purchased at medical supply stores.

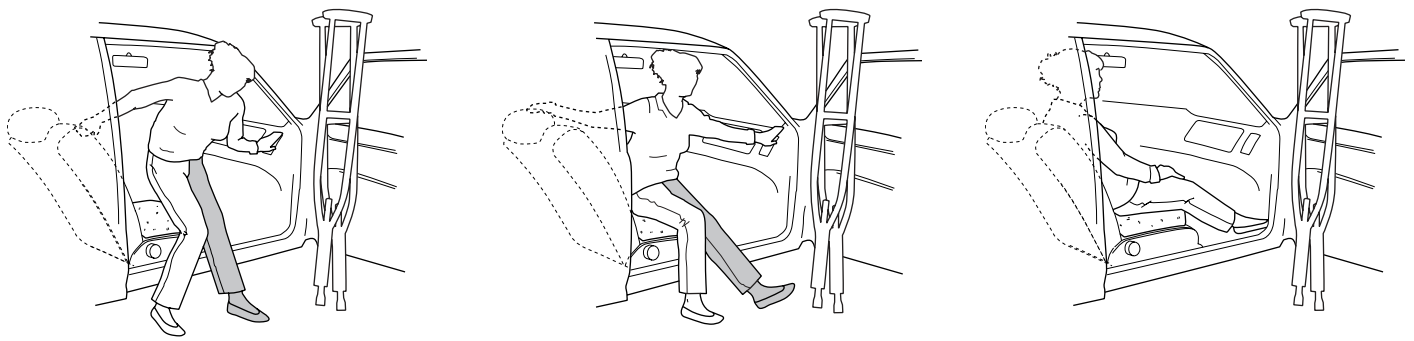

**Shaded leg is the surgical leg**

## Everyday Activity Guidelines

### Walking

You can expect to use walking aids, such as a walker, crutches or cane, for up to 3 months or longer after surgery. By 4 to 6 weeks after your surgery, you should be walking with more confidence, have more strength and be able to walk longer distances. Regular physiotherapy after your surgery will help you get the most out of your new joint. Physical activity will help you have a faster recovery and will get your blood moving. This will also reduce your risk of developing a blood clot.

### Stairs

It is a good idea to practice the stairs with the hospital physiotherapist so that you are able to manage stairs safely and independently. If you have had both knees replaced (bilateral), your physiotherapist will practice a technique with you that allows you to alternate your surgical legs when going up and down the stairs. *Shaded leg is the surgical leg.*

#### Going UP the stairs:

- Use a handrail and/or crutches, cane
- Step UP with your good (non-operated) leg first
- Follow with your operated leg and crutch, one stair at a time

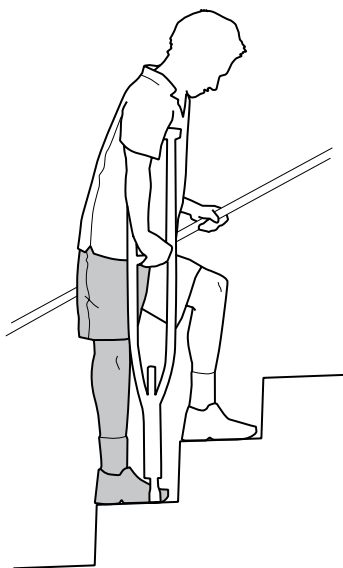

#### Going DOWN the stairs:

- Use the handrail or your crutches
- Place your crutch on the step below
- Step DOWN with your operated leg first
- Follow with your good (non-operated) leg, one stair at a time

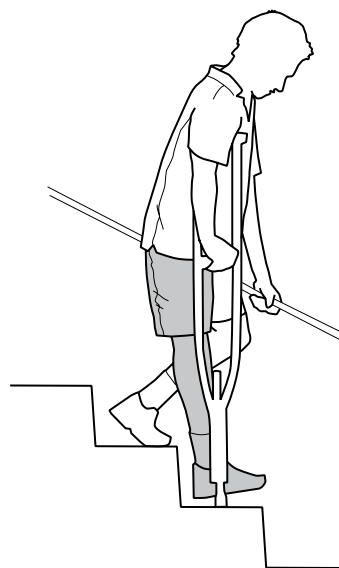

## Getting Into Bed

- Sit at the side of the bed. It may be easier to get into bed on your stronger side.
- Slide back across the bed using your arms for support
- If necessary, a half bed rail can allow you to get in and out of bed more easily. A half bed rail consists of a handle with 2 long metal rods that are placed between the mattress and the box spring. A half bed rail can be obtained through the Red Cross or medical supply stores.
- Lift your operated leg into bed or use a “leg lifter” (this may be the belt from your housecoat or a crutch turned upside down, hooked over your foot so you can help lift the leg using your arms) if needed
- **DO NOT use your non-operative leg to lift your surgical leg.**

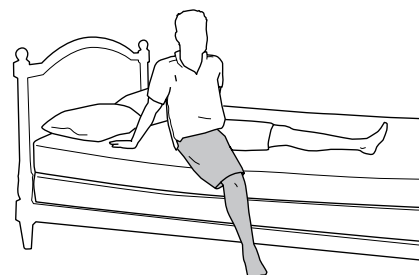

## Getting Out of Bed

- Slide your body to the edge of the bed
- Use your arms to push yourself to a sitting position. (If you have had hip surgery, do not push yourself up past 90 degrees. Remember your hip precautions!)
- Slide your operated leg off the bed
- Bring your body to a sitting position at the bedside

## Sitting Down

- Use a firm chair with arm rests
- If you have had hip surgery, measure the chair height against your leg before you sit. The chair should be 2 inches above your standing knee height. Use a high density foam cushion or bed blocks to increase the chair height.
- Back up to the chair until you feel the edge behind your knees
- Move your operated leg forward and reach back for the arm rests
- Slowly lower yourself into the chair



## Getting Dressed

- Sit on a raised chair or bed
- Dress your operated leg first and undress it last
- Use adaptive aids like a long-handled reacher, sock aid and shoehorn to reach the foot of your operated leg and put on socks, pants, shoes, etc. while protecting your new joint
- While you are in hospital, your occupational therapist will show you how to use these aids and give you tips on how to dress while maintaining joint precautions

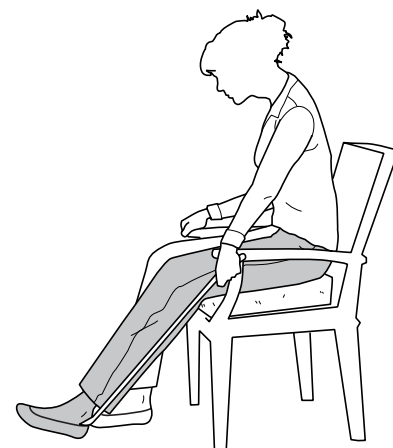

## Bathroom Safety

Falls can happen anywhere but are most likely in the bathroom. Here are ways to reduce the risk:

- Do not rush. Plan to use the toilet often. Have a bedside commode if needed.
- When bathing, use a bench or chair, non-slip bath mats, grab-bars and/or a removable tub clamp
- Make sure the route from your bedroom to the bathroom is well-lit
- Wear sensible, non-slip shoes or slippers
- If you feel dizzy or unsteady, talk to your family doctor

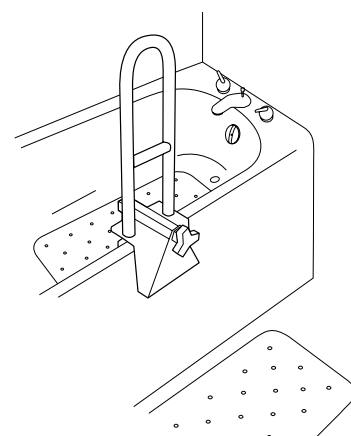

**Removable Tub Clamp**

## Using the Toilet

- Use a raised toilet seat for the first 3 months after your surgery
- Make sure that the toilet seat has secure armrests or that you can use the counter to push yourself up. You can also install grab bars to help you stand or sit. Do NOT use towel racks or toilet paper holders to help you stand or sit down.
- Toilet seat should be 2 inches above standing knee height
- Sit down as you would in a chair (see page 53)



**Raised Toilet Seat**

## Bathtub Transfer

- Use a tub transfer bench with a hand-held shower (in a bathtub) or shower chair (in a shower stall) for the first 3 months after surgery. Do NOT try to sit on the bottom of the tub.
- Remove glass shower doors on your tub and replace with a shower curtain
- Place a non-slip bathmat inside and outside the tub
- Your transfer bench or shower chair should be 2 inches above your standing knee height. If you are tall, you may need bench leg extensions.
- Sit down as you would in a chair (see page 53). Slide back as far as you can on the seat. Then lift your legs over the edge of the tub. Do not bend your hip past 90° if you have had hip surgery.
- Use long-handled aids to clean your feet and other hard-to-reach places
- A hand-held shower hose will allow you to bathe more easily. If you have had a hip replacement, you will not be able to reach forward for the taps due to hip precautions.
- Some surgeons will want you to do sponge-baths until your staples are removed in order to avoid getting the new incision wet

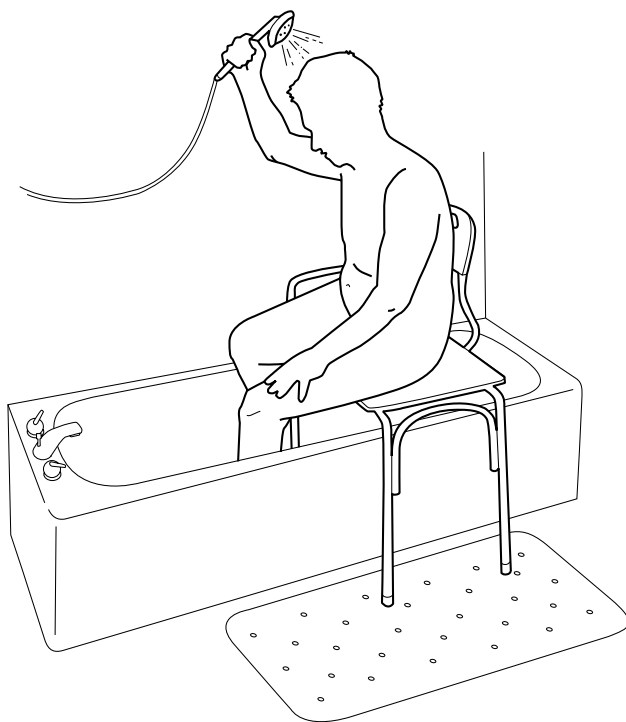

## Wound Care

You will have a cut (incision) at the site of your surgery. Your nurse will teach you how to care for your incision at home. While it is normal to have some redness and clear drainage from your wound, watch for signs of infection (*see page 60*). You do not need a bandage unless there is drainage.

The edges of your skin may be held together with sutures, staples or steri-strips. Staples are metal clips that hold the edges of your skin together while your skin heals. Your staples will be removed 7 to 14 days after surgery. If you have steri-strips, leave them alone. They will fall off on their own.

It is important to keep your incision dry until it is fully healed. Showering is permitted, but avoid aiming the shower head at your incision. Use mild soap, rinse the area well and gently pat dry.

## Sexual Activity After Hip Replacement:

- You may return to sexual activity when you feel ready and comfortable; this is often around 4 to 6 weeks after surgery
- You must maintain hip precautions for 3 months during all daily activities, including sexual activity
- Think about how you will maintain your hip precautions of not twisting and not bending more than 90 degrees
- You may need to consider trying some new positions. Talk to your partner.
- If you have questions or concerns about how to protect your new hip during sexual activity, talk to your occupational therapist, physiotherapist or surgeon.
- Visit the website: **[www.aboutjoints.com](http://www.aboutjoints.com)** for illustrations of sexual positions that maintain hip precautions



## Returning to Work

Allow yourself time to recover from surgery and focus on your rehabilitation before returning to work. Some people return to some form of work quickly after surgery but others need a longer time to heal and recover. This depends on factors such as health status and the type of work you do. Talk to a health care professional, such as an occupational therapist, about what is right for you.

### Work Environment Adaptations:

- **Chair:** Choose a standard chair for sitting. Avoid chairs with wheels; they can roll away from you when you are getting up. Use your high-density foam cushion to increase the seat height if necessary.
- **Desk:** Position your phone, paperwork and computer close to you. If you have had a hip replacement, you should NOT bend forward to reach these items. This will break your hip precautions.
- **Keyboard Tray:** If you have raised your chair and your desk is too low, use a height-adjustable keyboard tray so that you can sit comfortably while typing.
- **Schedule:** Plan lots of stretch breaks. Get up and move around frequently. Avoid sitting in the same position for more than 45 minutes at a time.
- **Bathroom:** Check the height of the toilets at the office and the location of grab bars.

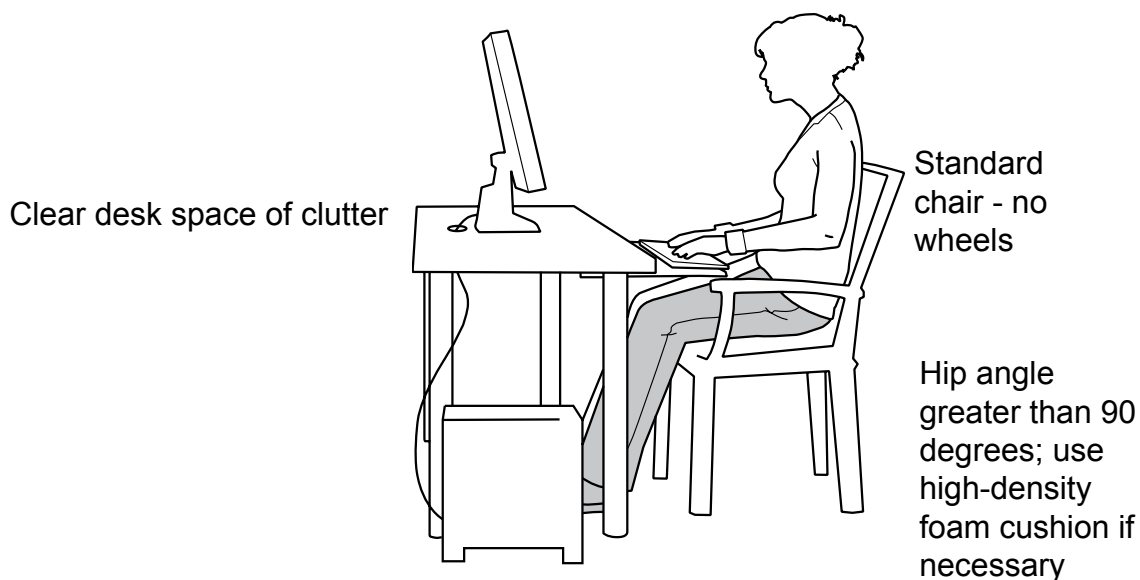

## **Complications**

After surgery, a few people have complications and need more medical treatment. Here are some possible complications:

- Constipation/bladder function
- Blood clots
- Swelling
- Infection
- Anemia (low blood count)
- Joint loosening
- Hip joint dislocation

### **Constipation/Bladder Function**

Constipation can be a problem after surgery. A change in your diet, less activity and pain medicine may make your constipation worse. Here are some ways to stay regular at the hospital and at home:

- Drink at least 8 glasses of water or low-calorie fluid a day
- Eat fibre, such as prunes, bran, beans, lentils, fruits and vegetables
- Move around as much as you can – do your exercises!

Your nurse may give you laxatives and/or stool softeners. You may need to keep taking these medicines at home. If you have constipation at home, talk to your family doctor or pharmacist. Constipation can be serious so do not ignore your symptoms.

Some patients have difficulty urinating after their joint surgery. Please talk to your nurse right away if you are having problems. You may need a catheter.

## Blood Clots

A small number of people may get blood clots after surgery. Blood clots usually develop in the deep veins in the legs. People who have problems with their circulation and/or are inactive are more likely to develop a blood clot.

To reduce the risk of blood clots:

- Take the anti-coagulation advised by your doctor.
- Walk short distances at least once an hour (except when you are sleeping).
- When you are sitting or in bed, pump your ankles and flex your leg muscles.

**Tell your family doctor or surgeon immediately if you have:**

- Pain, aching, heat or redness in your calf area
- Increasing severe swelling in your surgical leg

**Call 911 immediately if you have:**

- Shortness of breath
- Sudden chest pain

## Swelling

It is normal to have some swelling in your leg after surgery and during your recovery. Swelling may increase as you become more active. To help reduce swelling:

- Point and flex your feet hourly when awake
- Lie down flat and raise your legs (maintain hip or knee precautions) by placing pillows under the length of your leg
- Do short periods of activity. Walk a few steps. Rest. Repeat.
- Place an ice pack wrapped in a towel on your joint. For some people, a “cryocuff” may be used after knee replacement surgery. This is a type of ice pack/compression device for the lower leg. For more information, talk to your physiotherapist about using ice at home.

## **Infection**

Less than 1% of people have an infection around their new joint. An infection in the body can reach the new joint through the bloodstream. People who develop joint infections need antibiotics and, on rare occasions, further surgery. To prevent infection or incision problems, it is important to keep the incision and dressings dry. Do not touch or pick at the incision and maintain good cleanliness of the surrounding skin.

**Call your surgeon's office if you have any of these signs of infection:**

### **Incision Infection:**

- The area around your incision is becoming more red and the red is spreading
- New drainage (green, yellow or foul smelling pus) from the wound site. It is common for new surgical wounds to have some drainage for the first few (3-5) days after surgery but this will slowly stop and the wound should stay dry.
- There is increased pain or swelling of wound site and surrounding area
- Fever above 38°C or 101°F
- Call your surgeon if you think you have a possible wound infection

### **Urinary Tract Infection:**

- Pain when you urinate
- Frequent or urgent need to urinate
- Foul smelling urine
- Fever above 38°C or 101°F

### **Sore Throat/Chest Infection:**

- Swollen neck glands, pain when you swallow
- Frequent cough, coughing-up yellow or green mucous, shortness of breath
- Fever above 38°C or 101°F

### **Anemia (low blood count)**

If you have signs of anemia, see your family doctor. You may need an iron supplement. The signs of anemia are:

- Feeling dizzy or faint
- Feeling very tired
- Shortness of breath
- Rapid pulse

### **Joint Loosening**

Over many years, the bond between the joint replacement and your bone may loosen. This can cause pain and make it difficult for you to move your artificial joint. To reduce the risk of this complication, avoid high-impact physical activities. If you notice increased pain in your artificial joint, talk to your doctor as soon as possible.

### **Hip Joint Dislocation**

**Call 911** if your surgical leg is suddenly extremely painful, shortens, and the hip cannot be moved.

### **Dental Work and Medical Procedures**

It is important to tell your health care professional that you have had joint replacement surgery before having dental work or medical procedures (including procedures with the bladder, prostate, lung or colon). You may be put on antibiotics to prevent infection from moving through your bloodstream to your new joint. Talk to your dentist or doctor about what is right for you.

# Resources

## **Arthritis & Surgery Information**

OASIS Program;  
“Osteoarthritis Service  
Integration System”  
Vancouver Coastal Health

[www.vch.ca/oasis](http://www.vch.ca/oasis)

Email: [oasis@vch.ca](mailto:oasis@vch.ca)  
Phone: 604-875-4257

The Arthritis Society

[www.arthritis.ca](http://www.arthritis.ca)

Email: [info@arthritis.ca](mailto:info@arthritis.ca)

Arthritis Answers Line:  
1-800-321-1433

Canadian Orthopedic  
Association

[www.coa-aco.org](http://www.coa-aco.org)

Canadian Orthopedic  
Foundation

[https://  
whenithurtstomove.org/](https://whenithurtstomove.org/)

and Ortho Connect  
[www.canorth.org](http://www.canorth.org)

Bone and Joint Canada

[http://  
boneandjointcanada.  
com/](http://boneandjointcanada.com/)

Surgical or Orthopedic  
Information

American Academy of  
Orthopaedic Surgeons

[http://orthoinfo.aaos.  
org](http://orthoinfo.aaos.org)

## **Equipment**

Veterans Affairs Canada

[https://www.canada.  
ca/en/veterans-affairs-  
canada.html](https://www.canada.ca/en/veterans-affairs-canada.html)

Toll Free: 1-866-522-2122

Red Cross

[www.redcross.ca](http://www.redcross.ca)

Toll Free: 1-800-565-8000  
or check local listings for  
area phone number

## **Health Professionals**

HealthLinkBC

[www.healthlinkbc.ca](http://www.healthlinkbc.ca)

Phone: 8-1-1

Access Nurses, Dietitians,  
Medication Library &  
Check your symptoms

Physiotherapy

Association of British  
Columbia (PABC)

– to find a physiotherapist  
in your area

[www.bcphysio.org](http://www.bcphysio.org)

## **Home Safety**

Home Safety Renovations  
(low income seniors)

[www.cmhc-schl.gc.ca](http://www.cmhc-schl.gc.ca)

Toll Free:  
1-800-639-3938

## **Transportation**

HandyDART

[www.bctransit.ca](http://www.bctransit.ca)

Provided by local bus  
services throughout  
BC – check your local  
listings for phone  
numbers

SPARC –

disabled parking pass

[www.sparc.bc.ca](http://www.sparc.bc.ca)

Phone: 604-718-7744

TAP – Travel Assistance  
Program

[www.health.gov.bc.ca/  
msp/mtapp/tap\\_patient.  
html](http://www.health.gov.bc.ca/msp/mtapp/tap_patient.html)

Phone: 250-952-1587

# When to seek medical attention

## **CALL 911 if you develop:**

- Sudden severe pain in your surgical leg
- Inability to move the surgical leg
- Shortening of the leg
- Shortness of breath
- Chest pain

## **SEE your doctor if you develop:**

- Redness and drainage at the incision site
- Fever
- Severe fatigue
- Dizziness