

Department of Fisheries and Oceans

Freshwater Intake End-of-Pipe Fish Screen Guideline

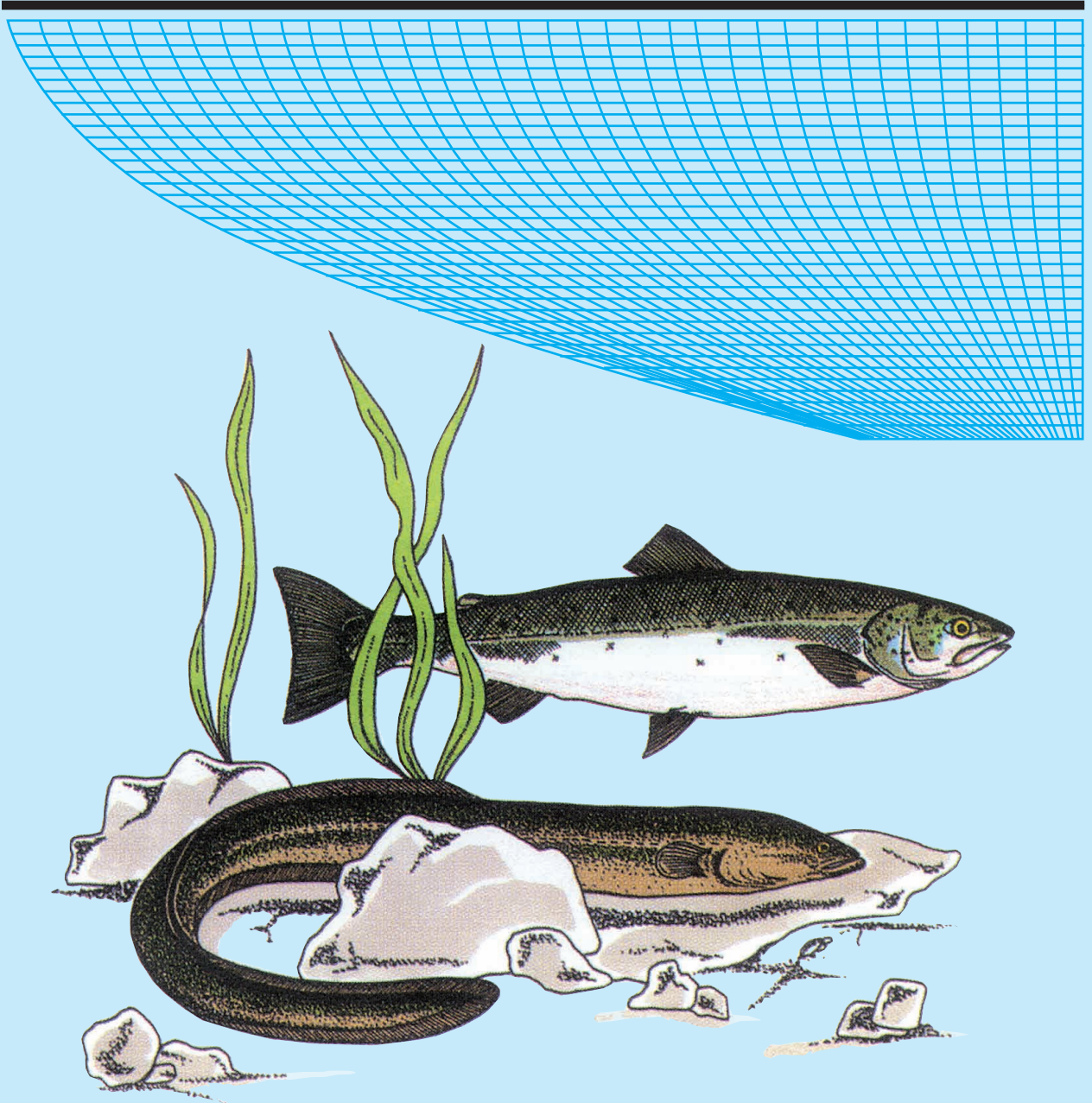
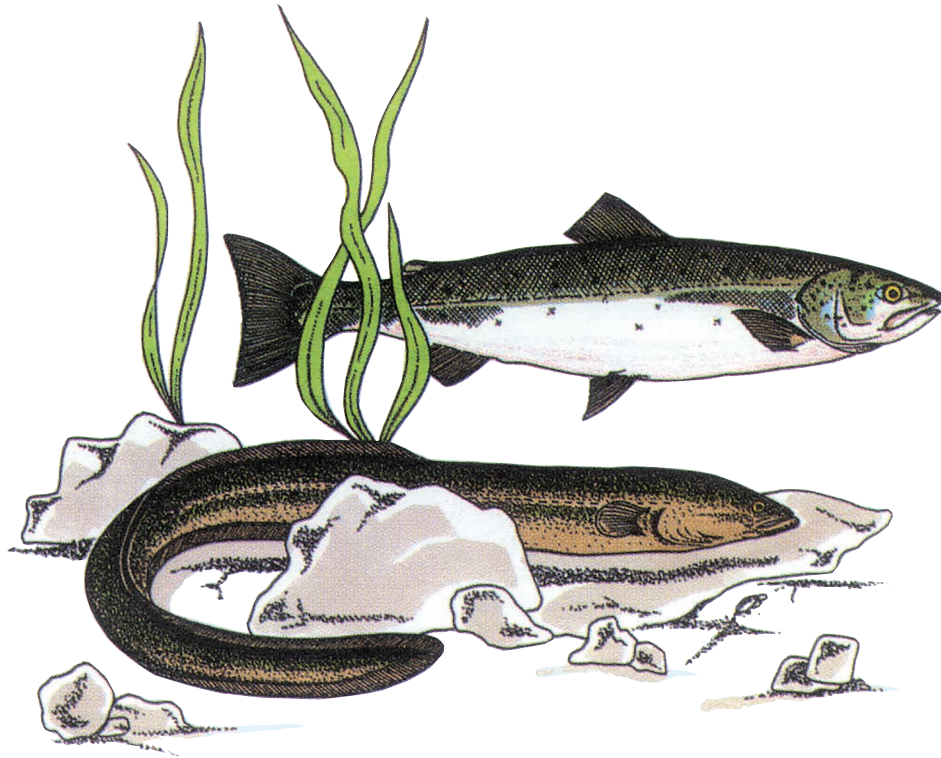

Department of Fisheries and Oceans

Freshwater Intake End-of-Pipe Fish Screen Guideline



Published by:

Communications Directorate
Department of Fisheries and Oceans
Ottawa, Ontario
K1A 0E6

DFO / 5080
© Minister of Supply and Services Canada 1995

ISBN 0-662-23168-6

Catalogue No. Fs 23-270 / 1995E



Printed on recycled paper

Table of Contents

1.0	Introduction	1
2.0	Guideline Objective	1
3.0	Information Requirements for Evaluation of Intake Screens	3
4.0	Design, Installation, and Maintenance of Freshwater intake End-of-Pipe Fish Screens	3
4.1	Fish Screen Criteria	4
4.2	Design of Fixed End-of-Pipe Fish Screens	6
4.3	Installation	8
4.4	Cleaning and Maintenance	15
	References	17
	Glossary	19
	Appendix A: Information Requirements	21
	Appendix B: Sample Calculation	23
	Appendix C: Units of Conversion	25
	Appendix D: DFO Regional Contacts	27

List of Figures

Figure 1 - Open Screen Areas for End-of-Pipe Water Intake Flows	9
Figure 2 - Common Screen Shapes and Area Formulae	10
Figure 3 - Typical Applications and Features of End-of-Pipe Screens	11
Figure 4 - Examples of Typical Screen and Material Types	12
Figure 5 - Examples of Typical Installations of End-of-Pipe Screens	13

List of Tables

Table 1 - Summary of Common Fish Species and Swimming Modes	5
Table 2 - Open Screen Area Required for End-of-Pipe Water Intakes	7
Table 3 - Examples of Screen Material	7

1.0

Introduction

The Department of Fisheries and Oceans (DFO) has prepared the **Freshwater Intake End-of-Pipe Fish Screen Guideline** to assist proponents in the design and installation of fish screens for the protection of anadromous and resident fish where freshwater is extracted from fish-bearing waters. This guideline will also assist regulatory agencies in the review of fish screen proposals.

A requirement for fish screening is stated under Section 30 of the *Fisheries Act*, where every water intake, ditch, channel, or canal in Canada constructed or adapted for conducting water from any Canadian fisheries waters must provide for a fish guard or a screen, covering, or netting over the entrance or intake so as to prevent the passage of fish into such water intake, ditch, channel or canal. Other sections of the *Fisheries Act*, or other Federal, Provincial, or Municipal Legislation and Policy may also apply to associated water extraction activities. Proponents are advised to contact the appropriate regulatory agencies regarding approvals or permits.

2.0

Guideline Objective

The objective of the guideline is to provide a National standard-of-practice and guidance for end-of-pipe fish screens at freshwater intakes to prevent potential losses of fish due to entrainment or impingement. Entrainment occurs when a fish is drawn into a water intake and cannot escape. Impingement occurs when an entrapped fish is held in contact with the intake screen and is unable to free itself. The severity of the impact on the fisheries resource and habitat depends on the abundance, distribution, size, swimming ability, and behaviour of the organisms in the vicinity of the intake, as well as, water velocity, flow and depth, intake design, screen mesh size, installation and construction procedures and other physical factors.

The **Freshwater Intake End-of-Pipe Fish Screen Guideline** deals exclusively with the sizing and design of fixed screens that are often placed at the end of a pipe used to extract water up to 0.125 m³/s, or 125 litres per second (L/s) (i.e., 2000 US gallons per minute (US gpm)). The guideline is intended for use in addressing fish screens for small permanent and temporary withdrawals for irrigation, construction, small municipal and

3.0

Information Requirements for Evaluation of Intake Screens

Information that should be provided to facilitate evaluation of an end-of-pipe intake screen design intended for fish protection during a freshwater withdrawal is highlighted below. Types of information requirements that may also be applicable to the water intake project as a whole are identified in Appendix A.

- fish presence, species, and possible fish size or fish habitat conditions at the project site
- rate or ranges of rates of withdrawal from the watercourse
- screen open and effective areas
- physical screen open parameters with respect to the intake and the watercourse
- screen material, method of installation and supporting structures
- screen maintenance, cleaning, or other special requirements

4.0

Design, Installation, & Maintenance of Freshwater Intake End-of-Pipe Fish Screens

The appropriate design of a fish screen is largely dependent upon the species and the size of fish requiring protection. Appropriate installation and maintenance/cleaning of the screen are also important in keeping approach velocities low and ensuring satisfactory operation of the screen. For the purposes of this guideline, emphasis is placed on the protection of freshwater fish with a minimum fork length of 25 mm from entrainment and impingement due to water extraction activities. Depending upon site-specific circumstances, a case may be made whereby the minimum fork length size of fish to be protected is greater than 25 mm. In this instance, the fish screen criteria for open screen area (Table 2 and Figure 1) and screen mesh size (2.54 mm) presented here do not apply. Fish screen criteria and guidance for the protection of fish larger than 25 mm is provided by Katopodis (1992).

The following sections address the appropriate design of fixed freshwater intake end-of-pipe fish screens for the protection of fish with a minimum fork length of 25 mm. Guidance on

installation, cleaning, and maintenance is provided. Common types of intake screens and associated intakes are also presented. Appendix B presents a sample calculation utilizing the guideline to determine the appropriate end-of-pipe intake screen size for the protection of freshwater fish.

4.1 Fish Screen Criteria

To protect fish from impingement or entrainment, the approach velocity (i.e., the water velocity into, or perpendicular to, the face of an intake screen) should not exceed certain values based on the swimming mode (i.e., subcarangiform or anguilliform) of the fish present in the watercourse. The subcarangiform group includes fish that swim like a trout or salmon, and move through the water by undulating the posterior third to half of their bodies. The anguilliform group includes fish that swim like an eel, and move through the water by undulating most or all of their body. Table 1 presents the swimming modes of most common fish species in Canada. Contact DFO or provincial fisheries agencies regarding fish species that are not included in Table 1.

Envelope curves for approach velocities were developed for each swimming mode corresponding to a minimum fork length of 25 mm and a maximum endurance time of 10 minutes (the time the fish is in front of the face of the screen before it can elude it). To satisfy approach velocities of approximately 0.11 m/s and 0.038 m/s for the subcarangiform and anguilliform groups respectively, curves indicating the required open screen areas, based on fish swimming performance data, including fish species and size (Katopodis, 1990) and related to flows/extractions, were developed. Table 2 presents the required open screen area, in both metric and non-metric units, for end-of-pipe intake screens with a capacity up to 125 L/s (2000 US gpm). The open screen area is the area of all open spaces on the screen available for the free flow of water. The same information is presented graphically in Figure 1.

A large grid of empty cells, likely a placeholder for a table or figure. The grid consists of approximately 20 rows and 6 columns of empty cells, with a thick horizontal line at the top and bottom.

Table 1
Summary of
Common Fish
Species and
Swimming Modes

SUBCARANGIFORM SWIMMING MODE

Common Name	Scientific Name
Alewife (Gaspereau)	<i>Alosa pseudoharengus</i>
Arctic Char	<i>Salvelinus alpinus</i>
Arctic Grayling	<i>Thymallus arcticus</i>
Atlantic Salmon	<i>Salmo salar</i>
Broad Whitefish	<i>Coregonus nasus</i>
Brook Trout	<i>Salvelinus fontinalis</i>
Brown Trout	<i>Salmo trutta</i>
Carp	<i>Cyprinus carpio</i>
Channel Catfish	<i>Ictalurus punctatus</i>
Chinook Salmon	<i>Oncorhynchus tshawytscha</i>
Chum Salmon	<i>Oncorhynchus keta</i>
Cisco	<i>Coregonus artedii</i>
Coho Salmon	<i>Oncorhynchus kisutch</i>
Cutthroat Trout	<i>Oncorhynchus clarki clarki</i>
Dolly Varden	<i>Salvelinus malma</i>
Goldeye	<i>Hiodon alosoides</i>
Green Sturgeon	<i>Acipenser medirostris</i>
Inconnu	<i>Stenodus leucichthys</i>
Kokanee	<i>Oncorhynchus nerka</i>
Lake Sturgeon	<i>Acipenser fulvescens</i>
Lake Trout	<i>Salvelinus namaycush</i>
Lake Whitefish	<i>Coregonus clupeaformis</i>
Largemouth Bass	<i>Micropterus salmoides</i>
Longnose Sucker	<i>Catostomus catostomus</i>
Mooneye	<i>Hiodon tergisus</i>
Mountain Whitefish	<i>Prosopium williamsoni</i>
Ouananiche	<i>Salmo salar ouananiche</i>
Pink Salmon	<i>Oncorhynchus gorbuscha</i>
Rainbow Smelt	<i>Osmerus mordax</i>
Rainbow Trout	<i>Oncorhynchus mykiss</i>
Sauger	<i>Stizostedion canadense</i>
Smallmouth Bass	<i>Micropterus dolomieu</i>
Sockeye Salmon	<i>Oncorhynchus nerka</i>
Walleye	<i>Stizostedio vitreum</i>
White Bass	<i>Morone chrysops</i>
White Perch	<i>Morone americana</i>
White Sturgeon	<i>Acipenser transmontanus</i>
White Sucker	<i>Catostomus commersoni</i>
Yellow Perch	<i>Perca flavescens</i>

ANGUILLIFORM SWIMMING MODE

Common Name	Scientific Name
American Eel	<i>Anguilla rostrata</i>
Burbot	<i>Lota lota</i>
Sea Lamprey	<i>Petromyzon marinus</i>

Note: The few data points available for Northern Pike (*Esox lucius*) are close to the anguilliform group.

4.2 Design of Fixed End-of-Pipe Fish Screens

Once the required open area has been found from Table 2 or Figure 1, the effective screen area must be calculated. It is the area occupied by the open spaces (i.e., open screen area) and the screen material available for the free flow of water. The effective screen area should be provided at the intake location and is determined as follows:

$$\text{Effective Screen Area (m}^2 \text{ or ft}^2\text{)} = \frac{\text{Open Screen Area (Table 2)}}{\left(\frac{\% \text{ Open Area (Table 3)}}{100} \right)}$$

It should be noted that if the percent (%) open screen area is maximized, then the effective screen area required for a given flow is minimized. The narrowest dimension of any opening on the screen is referred to as the design opening, regardless of opening shape. The maximum design opening for a fish of 25 mm fork length is estimated at 2.54 mm (0.10 inches). Guidance on screen openings and materials is presented below.

- The screen openings may be round, square, rectangular, or any combination thereof, but should not have any protrusions that could injure fish.
- Screen materials may include brass, bronze, aluminum, monel metal, galvanized or stainless steel, and plastics. The screen material should be resistant to corrosion and UV light.
- Note: clogging due to corrosion is minimized with the use of stainless steel.
- Welded wedge wire screens offer reduced debris clogging and increased open area and screen stiffness, in comparison to round wire mesh and punch plate.

Table 3 presents several common types of screening material that meet the requirements of wire diameter, clear opening width and percent open area,

The dimensions of the fish screen can be calculated after the correct shape, configuration, location, and method of installation have been determined. This will usually be determined after a site investigation and a review of these guidelines. Included in Figure 2 are common screen shapes and the associated

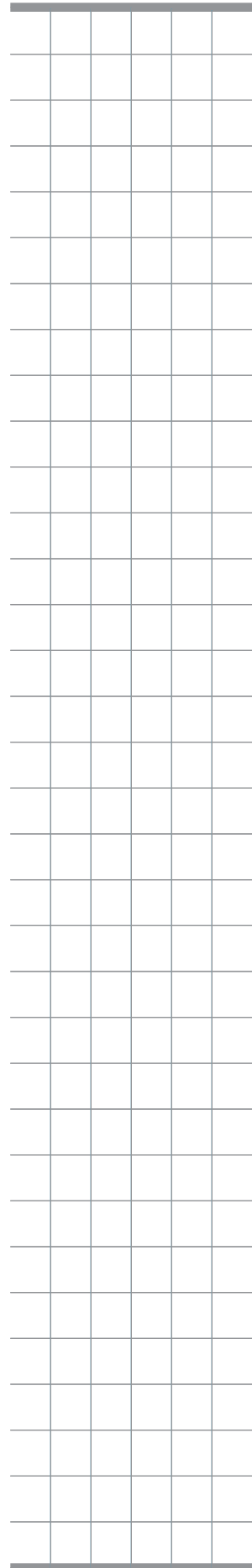

Table 2
Open Screen Area
Required for End-
of-Pipe Water
Intakes

Metric Units			Non-Metric Units		
Flow (L/s)	Subcarangiform (m ²)	Anguilliform (m ²)	Flow (US gpm)	Subcarangiform (ft ²)	Anguilliform (ft ²)
1	0.01	0.03	10	0.1	0.2
5	0.05	0.13	50	0.3	0.9
6	0.06	0.16	100	0.6	1.8
8	0.07	0.21	150	0.9	2.7
10	0.09	0.26	200	1.3	3.6
12	0.11	0.31	250	1.6	4.5
14	0.13	0.37	300	1.9	5.4
15	0.14	0.39	350	2.2	6.2
16	0.15	0.42	400	2.5	7.1
18	0.17	0.47	450	2.8	8.0
20	0.18	0.52	500	3.2	8.9
22	0.20	0.58	550	3.5	9.8
24	0.22	0.63	600	3.8	10.7
25	0.23	0.65	650	4.1	11.6
26	0.24	0.68	700	4.4	12.5
28	0.26	0.73	750	4.7	13.4
30	0.28	0.79	800	5.0	14.3
32	0.30	0.84	850	5.4	15.2
34	0.31	0.89	900	5.7	16.0
35	0.32	0.92	950	6.0	16.9
36	0.33	0.94	1000	6.3	17.8
38	0.35	0.99	1050	6.6	18.7
40	0.37	1.05	1100	6.9	19.6
45	0.42	1.18	1150	7.2	20.5
50	0.46	1.31	1200	7.6	21.4
55	0.51	1.44	1250	7.9	22.3
60	0.55	1.57	1300	8.2	23.2
65	0.60	1.70	1350	8.5	24.1
70	0.65	1.83	1400	8.8	25.0
75	0.69	1.96	1450	9.1	25.8
80	0.74	2.09	1500	9.4	26.7
85	0.78	2.23	1550	9.8	27.6
90	0.83	2.36	1600	10.1	28.5
95	0.88	2.49	1650	10.4	29.4
100	0.92	2.62	1700	10.7	30.3
110	1.02	2.88	1750	11.0	31.2
120	1.11	3.14	1800	11.3	32.1
125	1.16	3.30	1850	11.6	33.0
			1900	12.0	33.9
			1950	12.3	34.8
			2000	12.6	35.7

Table 3
Examples of Screen
Material

Material	Wire Thickness	Opening Width	% Open Area
8x 8 Stainless Steel Alloy Mesh	0.711 mm (0.028")	2.44 mm (0.096")	60
#7 Mesh Wire Cloth	1.025mm (0.041")	2.54 mm (0.100")	51
#8 Mesh Wire Cloth	0.875 mm (0.035")	2.25 mm (0.089")	52
#8 Mesh Wire Cloth	0.700mm (0.028")	2.54 mm (0.100")	62
#60 Wedge Wire Screen	1.50mm (0.059")	2.54 mm (0.100")	63
#45Wedge Wire Screen	1.10mm (0.080")	2.54 mm (0.100")	69

dimensions and area formulae. These are just examples of the many shapes and sizes in which fish screens can be fabricated. Screens are instream structures and, as such, should have sufficient strength and durability, and be capable of withstanding any potential large forces and impacts. Figure 3, 4, and 5 illustrate some of the various configurations, applications, and screen material types of end-of-pipe fish screens.

4.3 Installation

- Screens should be located in areas and depths of water with low concentrations of fish throughout the year.
- Screens should be located away from natural or man-made structures that may attract fish that are migrating, spawning, or in rearing habitat.
- The screen face should be oriented in the same direction as the flow.
- Ensure openings in the guides and seals are less than the opening criteria to make “fish tight”.
- Screens should be located a minimum of 300 mm (12 in.) above the bottom of the watercourse to prevent entrainment of sediment and aquatic organisms associated with the bottom area.
- Structural support should be provided to the screen panels to prevent sagging and collapse of the screen.
- Large cylindrical and box-type screens should have a manifold installed in them to ensure even water velocity distribution across the screen surface. The ends of the structure should be made out of solid materials and the end of the manifold capped.
- Heavier cages or trash racks can be fabricated out of bar or grating to protect the finer fish screen, especially where there is debris loading (woody material, leaves, algae mats, etc.). A 150 mm (6 in.) spacing between bars is typical.

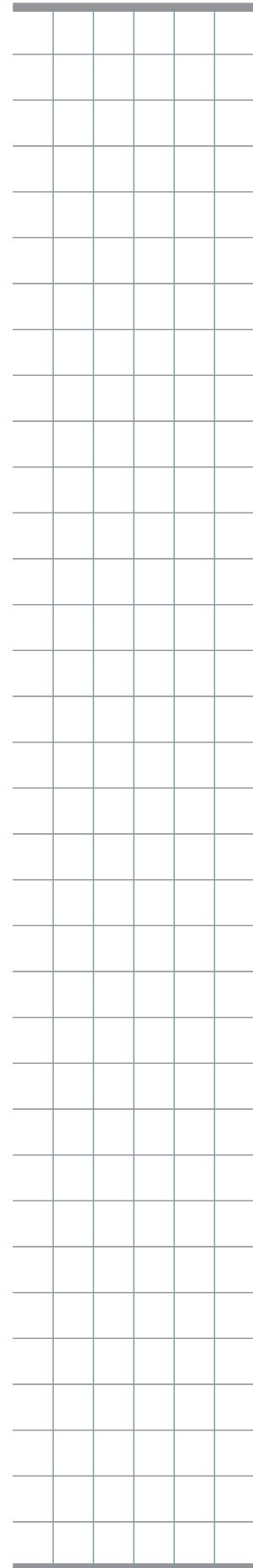

Figure 1
Open Screen Area
for End-of-Pipe
Water Intake Flow

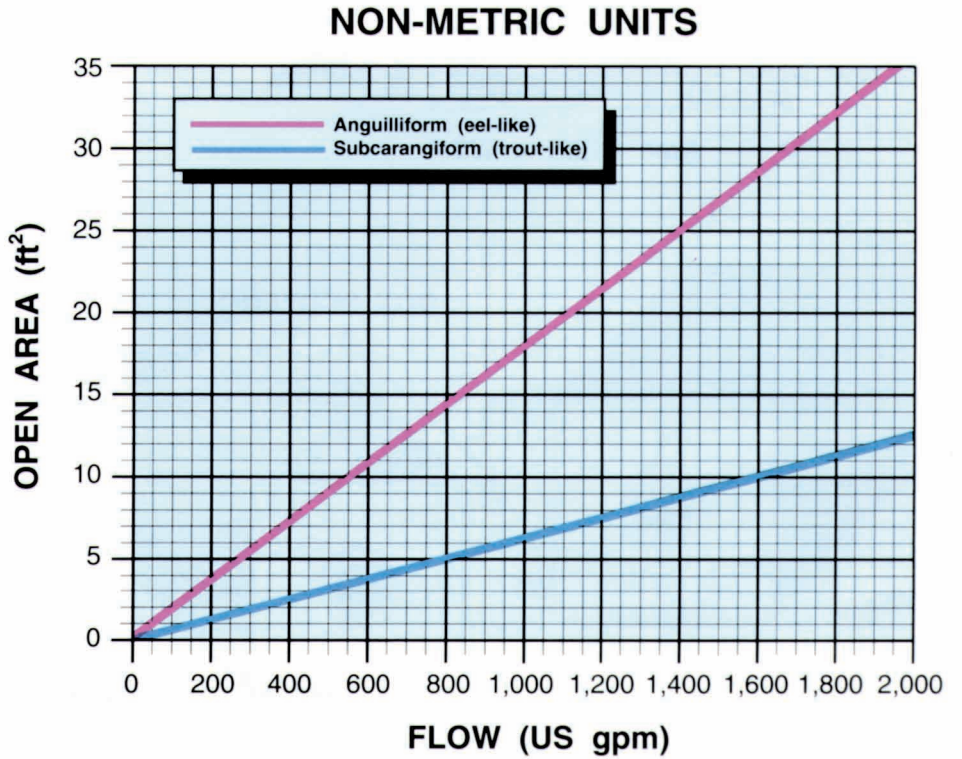
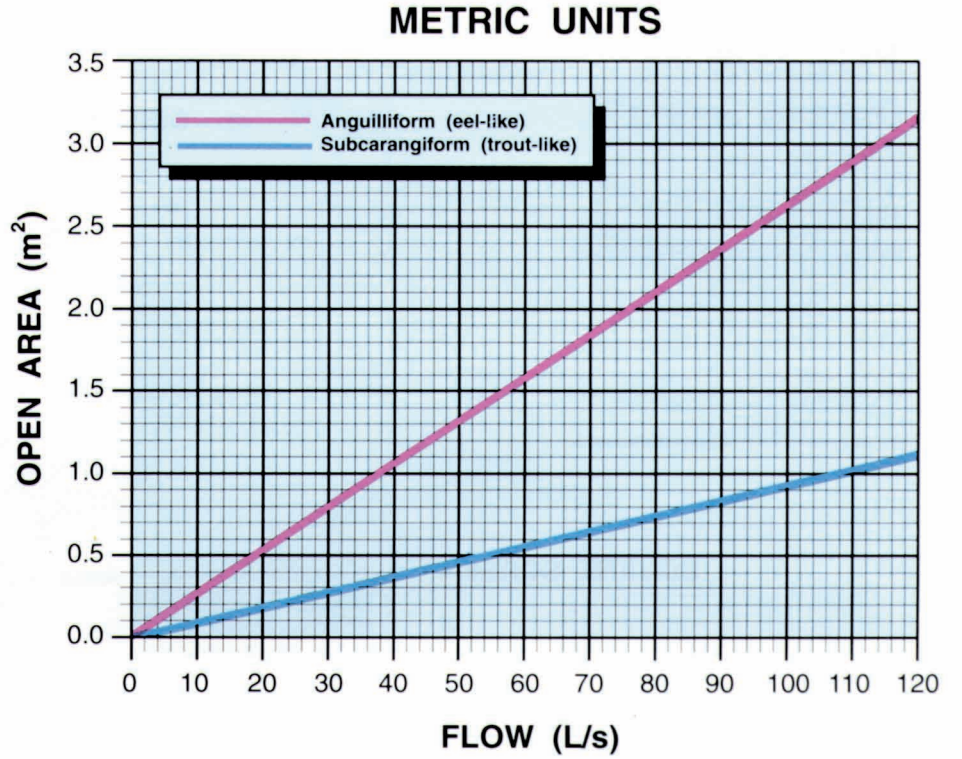
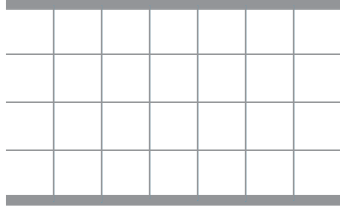
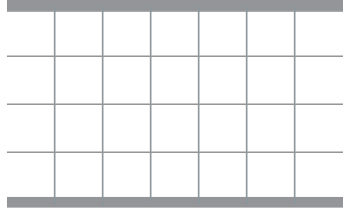
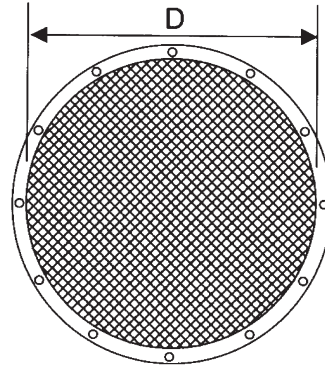

Figure 2
Common Screen
Shapes and Area
Formulae



CIRCULAR SCREEN



$$\text{Area} = \frac{\pi D^2}{4}$$

SQUARE SCREEN

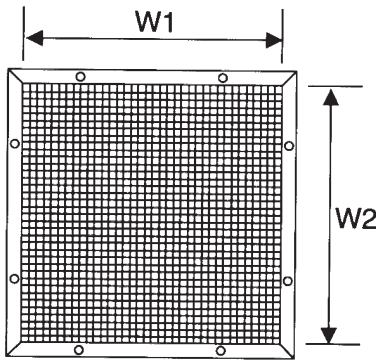

$$\text{Area} = W1 \times W2$$

CYLINDRICAL SCREEN

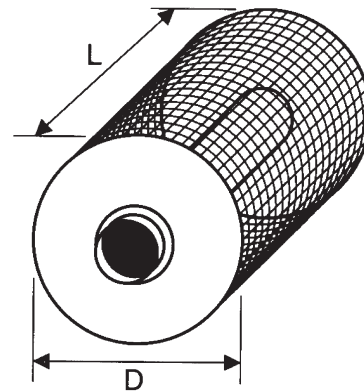

$$\text{Area} = \pi DL$$

BOX SCREEN

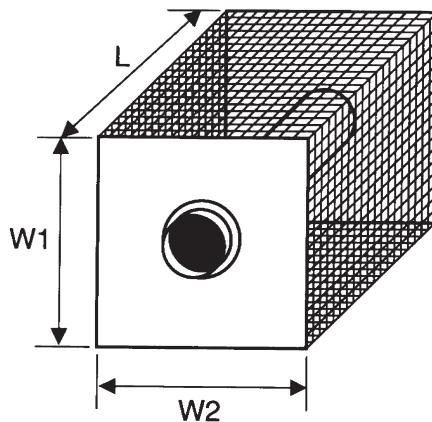

$$\text{Area} = 2L(W1 + W2)$$

Figure 3
Typical Applications
and Features of
End-of-Pipe Screens

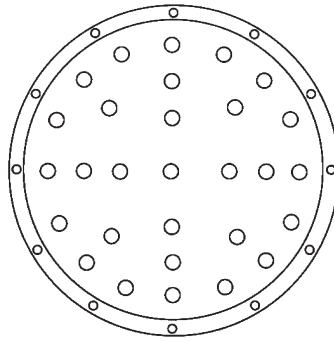
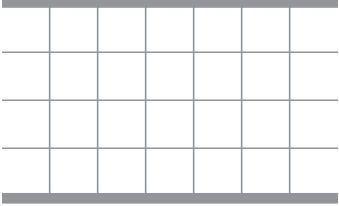

**PERFORATED PLATE
(PUNCHED)**

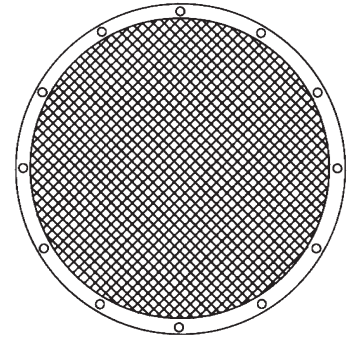

**CIRCULAR MESH
SCREEN**

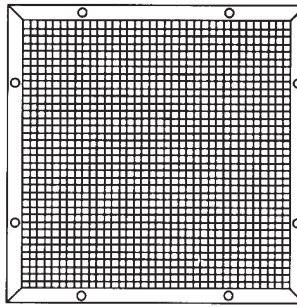

**SQUARE MESH
SCREEN**

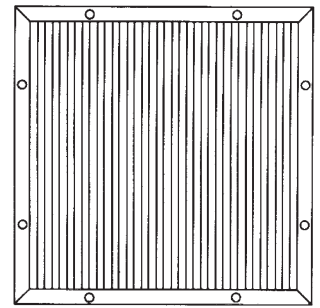

**SQUARE WEDGE WIRE
SCREEN**

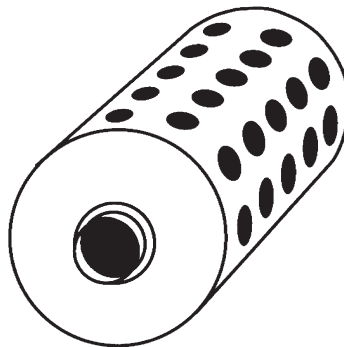

**DRUM OR CYLINDER
WITH PERFORATED PIPE**

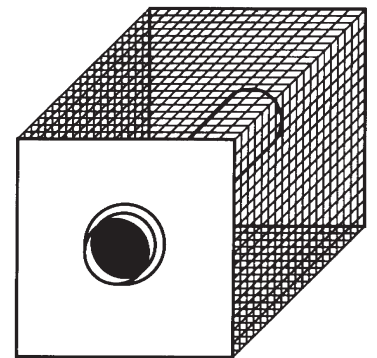

**BOX-TYPE WITH
MESH SCREEN**

Figure 4
Examples of Typical
Screen and Material
Types

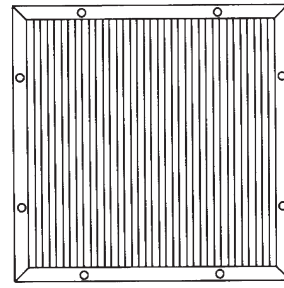
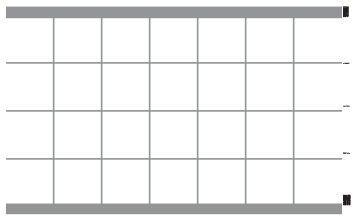

SQUARE WEDGE WIRE SCREEN

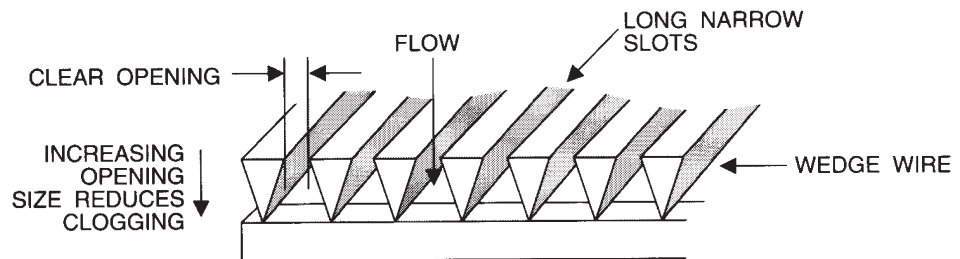

WEDGE WIRE PROFILE

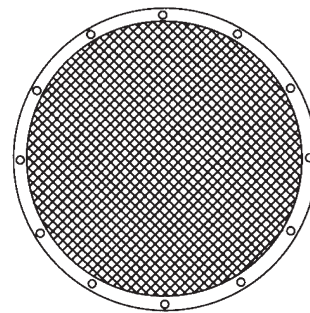

CIRCULAR MESH SCREEN

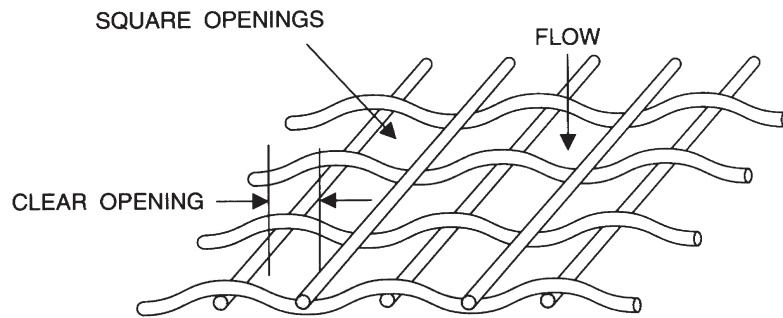

WOVEN WIRE MESH PROFILE

Figure 5
Examples of Typical
Installations of End-
of-Pipe Screen

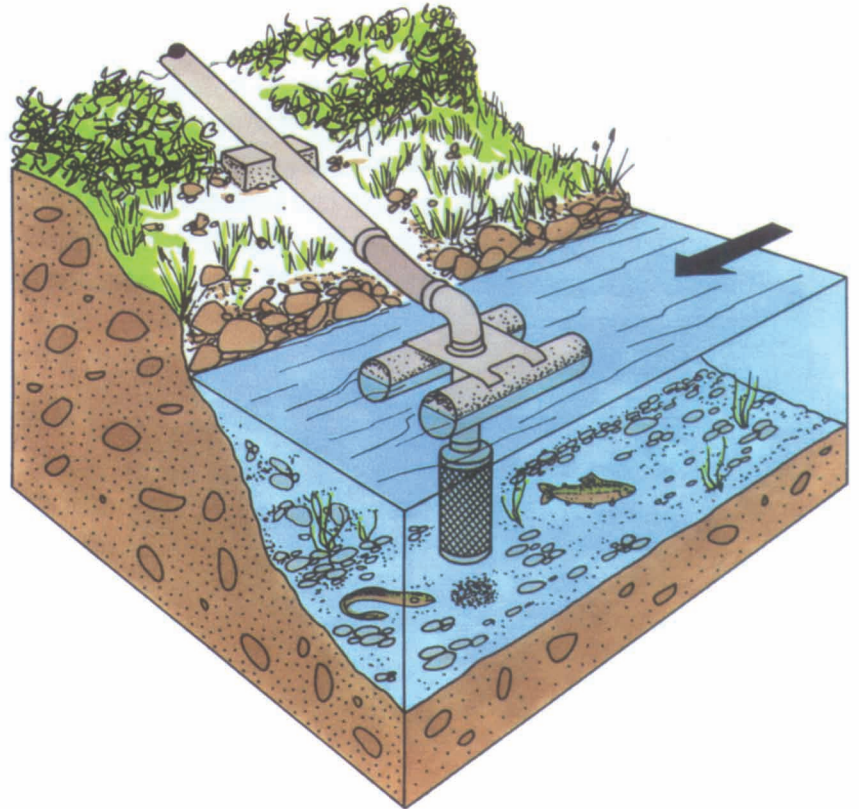
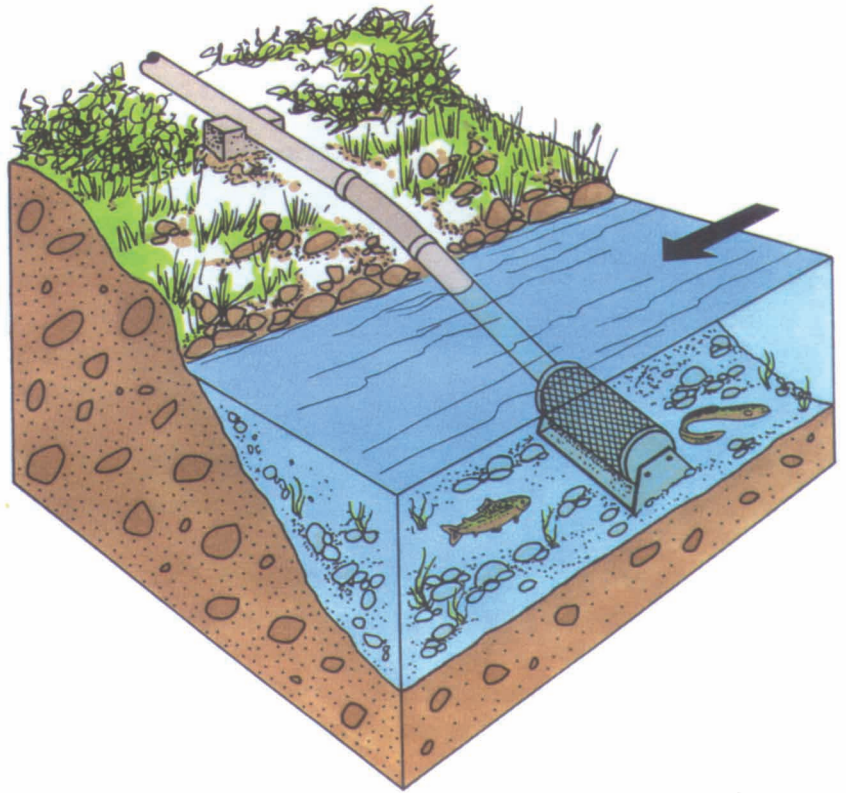

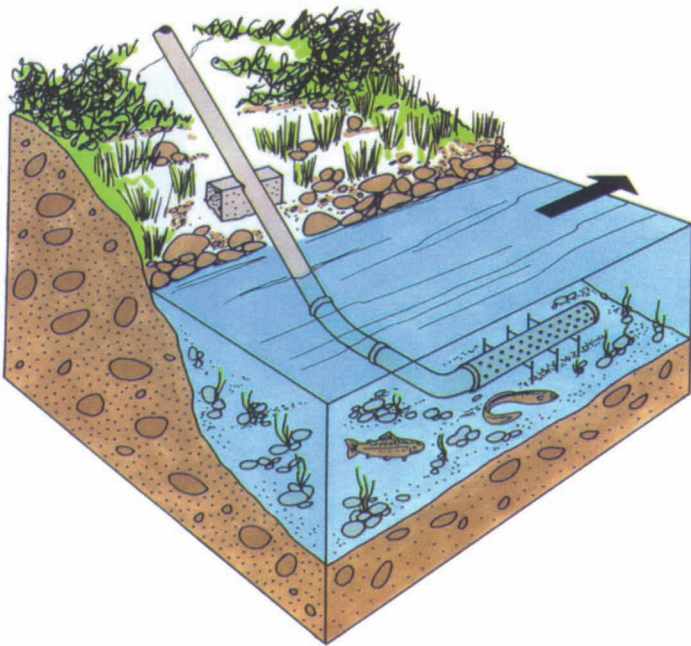
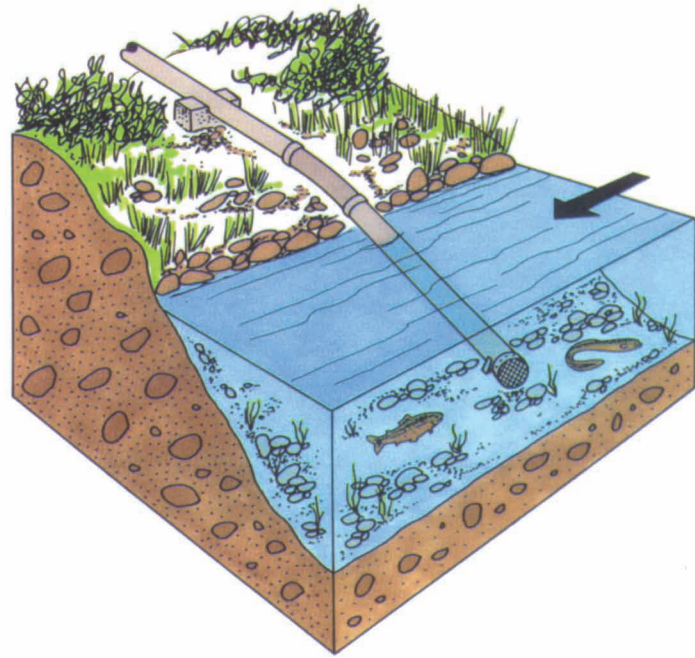
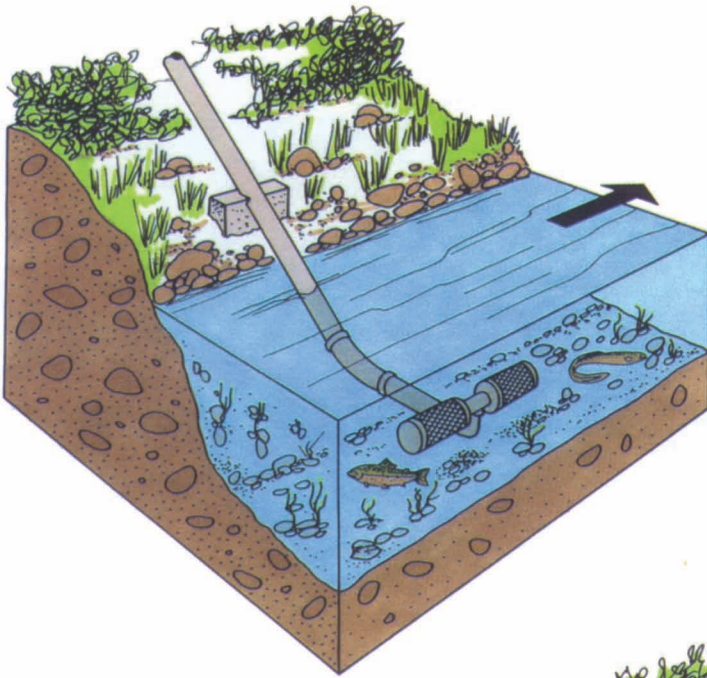

4.4 Cleaning and Maintenance

- Provision should be made for the removal, inspection, and cleaning of screens.
- Ensure regular maintenance and repair of cleaning apparatus, seals, and screens is carried out to prevent debris-fouling and impingement of fish.
- Pumps should be shut down when fish screens are removed for inspection and cleaning.
- Screens may be cleaned by methods such as air or water, backwashing, removal and pressure washing or scrubbing.
- Under certain site-specific winter conditions, it may be appropriate to remove screens to prevent screen damage.
- Flexible suction pipe may be used instead of solid, fixed piping for ease of screen removal and cleaning.
- Pump suction pressure can be measured to assess the need for screen cleaning.

To facilitate intake screen cleaning/maintenance, design and installation features such as orientation of the screen (e.g., in a cove) or variation in mesh shape (i.e., square wire/bars versus round wire/bars), etc. may be considered for regularly cleaned screens. For screens that will not be cleaned regularly, provision of considerably more open screen area (e.g., four times more) than determined from Table 2/Figure 1 may be considered. Such design/installation features should be addressed with the appropriate regulatory agencies on a site-specific basis.

Appendix C presents a list of units of conversion.

For more information on the appropriate design of freshwater intake end-of-pipe fish screens, contact the nearest DFO office. In addition, a list of DFO Regional contacts is presented in Appendix D. Other appropriate regulatory agencies should also be contacted.

References

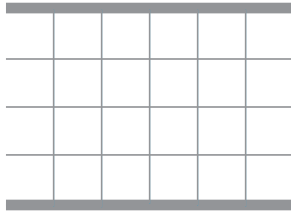

- Fish Screening Directive*. 1990. Department of Fisheries and Oceans, Ottawa, Ontario,
- Katopodis, C. 1990. *Advancing the art of engineering fishways for upstream migrants*. Proceedings of International Symposium on Fishways '90, Oct. 8-10, 1990, Gifu, Japan, p. 19-28.
- Katopodis, C. 1992. *Fish screening guide for water intakes*. Working Document, Freshwater Institute, Winnipeg, Manitoba.
- Katopodis, C. 1994. *Analysis of ichthyomechanical data for fish passage or exclusion system design*. Proc. International Fish Physiology Symposium, July 16-21, 1994, Vancouver, B.C. American Fisheries Society and Fish Physiology Association.
- Katopodis, C. and R. Gervais, 1991. *Ichthyomechanics*, Working Document, Department of Fisheries and Oceans, Freshwater Institute, Winnipeg, Manitoba.

Glossary

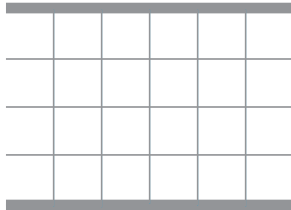

Anadromous:	Fish species that migrate from the sea to freshwater systems in order to spawn.
Anguilliform:	The type of swimming mode for fish that swim like an eel, and move through the water by undulating most or all of their body.
Effective Screen Area:	The area occupied by the open spaces (i.e., open screen area) and screen material available for the free flow of water.
Entrainment:	Occurs when a fish is drawn into a water intake and cannot escape.
Fork Length:	The straight line distance measured from the tip of the nose to the fork of the tail of a fish.
Impingement:	Occurs when an entrapped fish is held in contact with the intake screen and is unable to free itself.
Open Screen Area:	The area of all open spaces on the screen available for the free flow of water.
Subcarangiform:	The type of swimming mode for fish that swim like trout or salmon, and move through the water by undulating the posterior third to half of their body.

Appendix A Information Requirements

Appendix A Information Requirements

Types of information requirements that may be applicable to a freshwater intake proposal are highlighted below. While this listing is not intended to be all inclusive, it indicates information that may be necessary to enable regulatory agencies to review a water intake and fish screen proposal. The information highlighted below considers Section 30 and other sections of the *Fisheries Act*. These information requirements may also address other Federal, Provincial, and Municipal legislation and policies.

General and Site Information

- gazette or common name of the watercourse
- location of the watercourse
- type of watercourse (e.g., pond or stream)
- type of water intake
- other activities associated with the development or construction of the intake/screen structure

Biophysical Information

- fish presence, species, and possible fish size or fish habitat conditions at the protect site
- physical description of the watercourse at the intake site, including channel width and depth, direction and velocity of water currents, variations in wafer levels, sediment transport processes, lateral or channel grade movement, debris loading, etc.
- location and position of the intake within the watercourse, including dimensions, alignment, depth in the water column, wetted area, etc.
- description of the site features and characteristics, including site access

Water Use Information

- purpose of water withdrawal

Appendix B Sample Calculation

A proponent wishes to withdraw water at a rate of 0.075 m³/s from a nearby pond. The pond supports populations of brown trout, brook trout, and American eel. The intake is proposed to be cylindrical with the ends solid and #60 wedge wire screen around the cylinder.

What size must the intake screen be to satisfy the guideline requirements?

There are 4 steps to finding the answer:

1. Determine the fish swimming mode.
2. Determine the open screen area.
3. Determine the effective screen area.
4. Determine the dimensions necessary to produce the effective screen area.

1. Fish Swimming Mode

The fish swimming mode is found from Table 1. Brook trout and brown trout are listed as subcarangiform swimmers, while the American eel is an anguilliform swimmer.

2. Open Screen Area

Table 2 lists the required open screen area for both subcarangiform and anguilliform swimmers under flows up to 125 L/s (2000 US gpm). To use the table, it is necessary first to convert the flow from cubic metres per second to litres per second.

$$0.075 \frac{\text{m}^3}{\text{s}} \times \frac{1000 \text{ L}}{1 \text{ m}^3} = 75 \frac{\text{L}}{\text{s}}$$

For a flow of 75 L/s, Table 2 indicates that the open screen area must be:

- 0.69 m² for subcarangiform swimmers, and
- 1.96 m² for anguilliform swimmers.

The higher number (1.96 m²) is the more stringent requirement, therefore, it is used in the calculation of effective screen area,

3. Effective Screen Area

The screen material in this case is # 60 Wedge Wire. A review of Table 3 indicates that the % Open Area for this material is 63%, With this value and the previously determined area from Step 2, the following formula is used to determine the Effective Screen Area.

$$\begin{aligned}\text{Effective Screen Area} &= \frac{\text{Open Screen Area}}{\left(\frac{\% \text{ Open Area}}{100}\right)} \\ &= \frac{1.96 \text{ m}^2}{\left(\frac{63}{100}\right)} \\ &= 3.111 \text{ m}^2\end{aligned}$$

4. Dimensions of Intake Screen

Figure 2 lists several common screen shapes and their respective area formulae. For a cylindrical screen where the ends are solid and screening is around the cylinder, the following formula applies:

$$\text{Area} = \pi DL$$

The unknown dimensions are diameter (D) and length (L). These dimensions are determined by choosing a value for one and solving the equation for the other.

If the diameter is 0.600 m, then the length follows as:

$$\text{Area} = \pi DL$$

$$3.111 \text{ m}^2 = (0.600 \text{ m})L$$

$$3.111 \text{ m}^2 = (1.885 \text{ m})L$$

$$L = \frac{3.111 \text{ m}^2}{1.885 \text{ m}}$$

$$L = 1.65 \text{ m}$$

A 0.600 m diameter, 1.65 m long cylindrical screen would meet the design requirements. It should be noted that the dimensions given are representative of the screening area only; they do not include any screen that may be blocked by framing, etc. By comparison, if the pond only supported trout (subcarangiform), a 0.600 m diameter, 0.58 m long cylindrical screen would meet the design requirements.

Appendix C Units of Conversion

To Convert	Into	Multiply By
cubic feet per second	cubic metres per second	0.0283
cubic feet per second	litres per second	28.3
cubic feet per second	US gallons per minute	448.9
cubic metres per second	cubic feet per second	35.3
cubic metres per second	US gallons per minute	15850
litres per second	cubic feet per second	0.0353
litres per second	cubic feet per minute	2.12
litres per second	cubic metres per second	0.001
litres per second	US gallons per minute	15.85
square metre	square foot	10.76
square metre	square inch	1550
square foot	square metre	0.0929
US gallons per minute	litres per second	0.0631
US gallons per minute	cubic feet per second	0.00223
US gallons per minute	Imperial gallons per minute	0.833
Imperial gallons per minute	litres per second	0.0758

Appendix D
DFO Regional
Contacts

NEWFOUNDLAND REGION Habitat Management Division
P.O. Box 5667
St. John's NF A1C 5X1
Tel: 709-772-6157
Fax: 709-772-5562

GULF REGION Habitat Management Division
P.O. Box 5030
Moncton NB E1C 9B6
Tel: 506-851-6252
Fax: 506-851-6579

SCOTIA-FUNDY REGION Habitat Management Division
P.O. Box 550
Halifax NS B3J 2S7
Tel: 902-426-6027
Fax: 902-426-1489

QUEBEC REGION Fish Habitat Management
P.O. Box 15550
Quebec QC G1K 7Y7
Tel: 418-648-4092
Fax: 418-648-7777

CENTRAL & ARCTIC REGION Habitat Management
501 University Crescent
Winnipeg MB R3T 2N6
Tel: 204-983-5181
Fax: 204-984-2404

PACIFIC REGION Habitat Management
555 W. Hastings St.
Vancouver BC V6B 5G3
Tel: 604-666-6566
Fax: 604-666-7907

Local DFO offices should be contacted. Other appropriate regulatory agencies should also be contacted.